

**Industrial Silencer, Heat Recovery and Catalytic Specialists**

**Maxim Silencers  
Accessory  
Catalog**

Revision: M-ACCS-003.4



Prices are subject to change without notice.  
Prices are in U.S. dollars

Minimum order \$100, expedited fees minimum \$50  
Custom orders may require payment in advance.  
Custom items are non-returnable and non-refundable.

Returns must be approved by Maxim Silencers in advance. Upon approval an RMA will be issued.  
Return shipments are prepaid by customer, unless otherwise authorized by Maxim Silencers.  
Restocking charges may be applied.

Maxim Silencers products are warranted for one year from date of purchase by the consumer against defects due to materials and workmanship only. In case of a defective product, Maxim Silencers shall be the sole judge in determining the nature of the defect. Maxim Silencers sole obligation shall be to repair, or at Maxim Silencers option, to replace said products providing the originals are returned to Maxim Silencers. All returned items must be pre-approved by Maxim Silencers. All return shipments must be prepaid by the consumer. Defects or failures due to improper or careless installation, storage, handling, or application shall be excluded from this warranty. Failure to comply or contrary usage to Maxim Silencers directions, specifications or design, of which Maxim Silencers shall be sole judge, voids this warranty and all said products are specifically excluded from this warranty. No liability for damage or loss of any nature arising from or out of the use of this product, whether or not defective, is assumed. No liability is accepted for return transportation charges, following the repair or replacement, as previously mentioned, or for reinstallation costs. No other expressed or implied warranties exist in the absence of special written agreement between the consumer and Maxim Silencers.

# TABLE OF CONTENTS

Part	Assembled Accessories	Page	Part	Assembled Accessories	Page
	Table of Contents	3	M-41	Flanges ANSI Plate	25
	Corrugated Flex Specs	4	M-45	Flanges Threaded	26
	Expansion Joint/Bellows Specs	4	M-46	Flanges Reducing/Increasing Pipe & Tube	26
M-10	Corrugated Flex Connectors	5-7		Gasket Specs	27
M-11	Expansion Joint/Bellows	8-10	M-47	Nut Bolt Gasket Kits	28
M-13	Wyes Cummins Engine Wyes	11	M-48	Gaskets	29
M-14	Wyes MTU Detroit Engine Wyes	12	M-49	Tube Fittings Cuffed One End	30
M-15	Wyes Caterpillar Engine Wyes	13	M-50	Tube Fittings Cuffed Both Ends	30
M-20-A	Thimbles Combustible Walls Only	14	M-51	Tube Fittings Reducer/Expander	30-31
M-20-B	Thimbles Roof & Non Combustible Walls	14	M-52	Tube Fittings Connectors/Stack Breakers	31
M-21	Roof Jacks Cuff Style	15	M-53	90° Tube Elbow Long Cuffed One End	32
M-22	Rain Caps Standard and Heavy Duty	16-17	M-54	90° Tube Elbow Long OD Tube Both Ends	32
M-23	90° Tube Elbow Flanged One End	18	M-55	90° Tube Elbow Short Tangent Cut	32
M-24	90° Mitered Elbow Flanged One End	18	M-55-M	90° Mitered Elbow Short Tangent Cut	32
M-25	Outlet Extension Tube Flanged One End	19	M-56	90° Tube Elbow Short Cuffed One End	33
M-25	Outlet Extension Tube 45° w/ Bird Screen	19	M-57	90° Tube Elbow Short OD Tube Both Ends	33
M-25	Outlet Extension Tube Flanged Both Ends	20	M-58	45° Tube Elbow Long Cuffed One End	33
M-26	90° Tube Elbow Flanged Both Ends	20	M-59	45° Tube Elbow Long OD Tube Both Ends	33
M-26-M	90° Mitered Elbow Flanged Both Ends	20	M-60	45° Tube Elbow Short Cuffed One End	34
			M-61	45° Tube Elbow Short OD Tube Both Ends	34
			M-62	45° Tube Elbow Short Tangent Cut	34
			M-63	Flex Hose Stainless Steel Interlocking	35
			M-64	Tubing	35
			M-65	Flex Hose Stainless Steel Corrugated	35
			M-67	Cones	36
			M-80	Rain Guards Flange Style	37
			M-81	Rain Guards ID Cuff Style	37
			M-82	Drain Cocks	37
				Thermal Specifications	38
			M-103	Thermal Wrap Tubing	39
			M-104	Thermal Wrap Bellows & Flex	39
			M-105	Thermal Wrap Elbow	40
			M-106	Thermal Wrap ANSI Flange	41

Part	Assembled Accessories	Page
M-27	Pipe Hangers	21
M-29	Brackets	22
M-31	Clamps Circle	23
M-32	Clamps Round Bolt	23
M-33	Clamps Seal	23
M-35	Clamps V-Band	23
M-36	Flanges Flared	24
M-37	Flanges Machined Turbo	24
M-38	Flanges Caterpillar Engine	24
M-39	Flanges MTU Detroit Engine	24
M-40	Flanges Cummins Engine	24

# SPECIFICATIONS

## M-10 Flex and M-11 Bellows Specifications

Specifications for Flex Connectors				
Nominal Hose ID (in.)	Nominal Hose OD (in.)	Max Lateral Offset / Foot	Max Axial Movement / Foot	Max Operating Temperature (°F)
2	2.75	0.96	0.14	1500°
2.5	3.17	0.82	0.22	1500°
3	3.75	0.74	0.22	1500°
4	4.82	0.6	0.22	1500°
5	5.87	0.47	0.22	1500°
6	6.94	0.42	0.22	1500°
8	9	0.30	0.22	1500°
10	11	0.20	0.22	1500°
12	13	0.17	0.22	1500°

Specifications for Single Ply Bellow (Expansion Joints)											
Nominal Size (in.)	PSIG	TEMP (°F)	Axial Comp		Lateral Offset		Axial Spring		Lateral Spring		Fatigue* Cycle
			S	L	S	L	S	L	S	L	
3	5	1200°	2.0	3.0	0.125	0.125	96	73	21	73	10,000
4	5	1200°	2.0	3.0	0.125	0.125	124	95	46	20	10,000
5	5	1200°	2.5	3.5	0.125	0.125	144	108	85	36	10,000
6	5	1200°	2.5	3.5	0.125	0.125	169	127	138	58	10,000
8	5	1200°	2.5	3.5	0.125	0.125	219	164	303	128	10,000
10	5	1200°	3.0	4.0	0.125	0.125	215	167	478	209	10,000
12	5	1200°	3.0	4.0	0.125	0.125	257	200	800	375	10,000
14	5	1200°	3.0	4.0	0.125	0.125	204	163	869	391	10,000
16	5	1200°	3.0	4.0	0.125	0.125	232	182	1265	659	10,000
18	5	1200°	3.0	4.0	0.125	0.125	260	208	1767	795	10,000
20	5	1200°	3.0	4.0	0.125	0.125	288	231	2387	1,074	10,000
22	5	1200°	3.0	4.0	0.125	0.125	316	253	3137	1,411	10,000
24	5	1200°	3.0	4.0	0.125	0.125	344	275	4028	1,812	10,000

\*Numbers vary depending upon overall length. Movements are concurrent. Numbers presented are for short and long size bellows capsules.  
 \*\*All bellows designs are per Expansion Joint Manufacturers Association 9th Edition. All dimensions are in inches. Larger diameters available upon request.



# M-10 FLEX CONNECTORS

## Corrugated Flex Connectors

### Floating ANSI Flange / ANSI Flange

Part Number	A	B	WT
M-10-1F1-3518	3.5	18	18
M-10-1F1-418	4	18	20
M-10-1F1-518	5	18	24
M-10-1F1-618	6	18	28
M-10-1F1-818	8	18	39
M-10-1F1-1018	10	18	51
M-10-1F1-1218	12	18	64

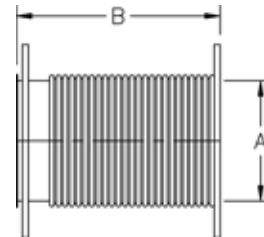

### Male NPT / ANSI Flange

Part Number	A	B	WT
M-10-21-218	2	18	9
M-10-21-2518	2.5	18	10
M-10-21-318	3	18	12
M-10-21-3518	3.5	18	14
M-10-21-418	4	18	16

Threaded pipe nipples may be replaced with plain pipe stubs.

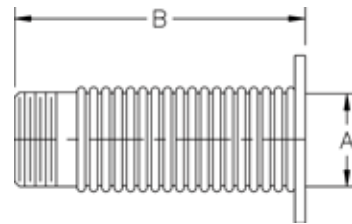

### Male NPT / Male NPT

Part Number	A	B	WT
M-10-22-218	2	18	6
M-10-22-2518	2.5	18	6
M-10-22-318	3	18	8
M-10-22-3518	3.5	18	10
M-10-22-418	4	18	11

Threaded pipe nipples may be replaced with plain pipe stubs.

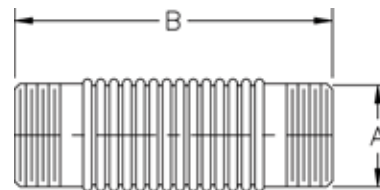

### Female Half Coupling / ANSI Flange

Part Number	A	B	WT
M-10-31-218	2	18	9
M-10-31-2518	2.5	18	10
M-10-31-318	3	18	12
M-10-31-3518	3.5	18	15
M-10-31-418	4	18	16

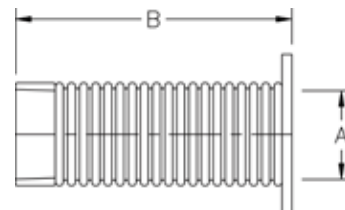

All dimensions are in inches. All weights are in pounds. Weights are approximate. Larger sizes available. All ANSI flanges may be replaced with a standard Caterpillar, Cummins, or MTU engine flanges. Flex is 321 stainless steel. End connections are carbon steel. Connections available in stainless steel.

# M-10 FLEX CONNECTORS

## Corrugated Flex Connectors

### Slotted ID Cuff / ANSI Flange

Part Number	A	B	WT
M-10-41-218	2	18	9
M-10-41-2518	2.5	18	10
M-10-41-318	3	18	10
M-10-41-3518	3.5	18	13
M-10-41-418	4	18	14
M-10-41-518	5	18	16
M-10-41-618	6	18	19

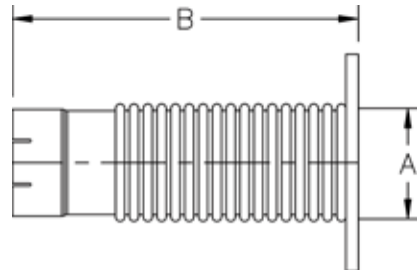

### Slotted ID Cuff / Male NPT

Part Number	A	B	WT
M-10-42-218	2	18	5
M-10-42-2518	2.5	18	6
M-10-42-318	3	18	7
M-10-42-3518	3.5	18	8
M-10-42-418	4	18	9

Threaded pipe nipples may be replaced with plain pipe stubs.

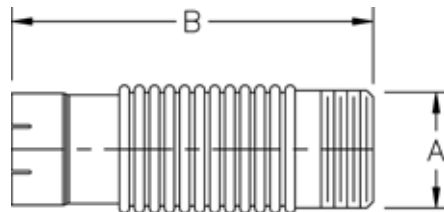

### Slotted ID Cuff / Female Half Coupling

Part Number	A	B	WT
M-10-43-218	2	18	5
M-10-43-2518	2.5	18	6
M-10-43-318	3	18	6
M-10-43-3518	3.5	18	8
M-10-43-418	4	18	9

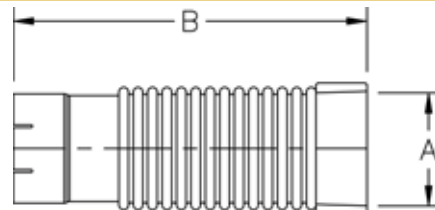

### Slotted ID Cuff / Slotted ID Cuff

Part Number	A	B	WT
M-10-44-218	2	18	5
M-10-44-2518	2.5	18	5
M-10-44-318	3	18	5
M-10-44-3518	3.5	18	6
M-10-44-418	4	18	7
M-10-44-518	5	18	8
M-10-44-618	6	18	10
M-10-44-818	8	18	12
M-10-44-1018	10	18	17

Tube ends may be substituted

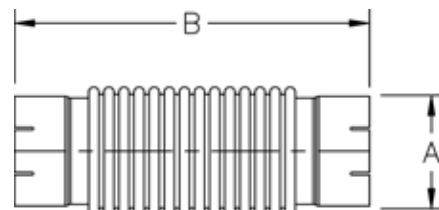

All dimensions are in inches. All weights are in pounds. Weights are approximate. Larger sizes available. All ANSI flanges may be replaced with a standard Caterpillar, Cummins, or MTU engine flanges. Flex is 321 stainless steel. End connections are carbon steel. Connections available in stainless steel.



# M-10 FLEX CONNECTORS

## Corrugated Flex Connectors

### Floating ANSI Flange / 90° Elbow / Floating ANSI Flange

Part Number	A	B	C	WT
M-10-1F61F-600-B65C18	6	6.5	18	27
M-10-1F61F-800-B9C24	8	9	24	48
M-10-1F61F-1000-B11C24	10	11	24	63
M-10-1F61F-1200-B13C24	12	13	24	84

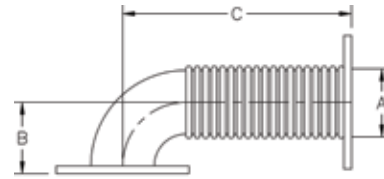

### Floating ANSI Flange / 90° Elbow / Slotted ID Cuff

Part Number	A	B	C	WT
M-10-1F64-400-B45C18	4	4.5	18	14
M-10-1F64-500-B55C19	5	5.5	19	18
M-10-1F64-600-B65C20	6	6.5	20	22

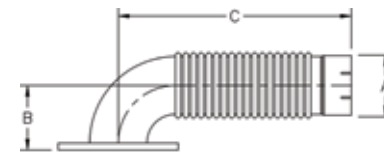

### Flared Flange / 90° Elbow / Floating ANSI Flange

Part Number	A	B	C	WT
M-10-761F-500-B8C23.25	5	8	23.25	19
M-10-761F-600-B9C24.50	6	9	24.50	23

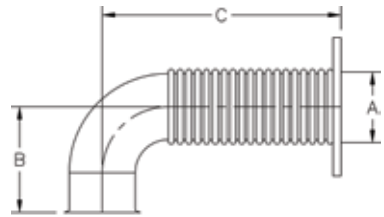

### Flared Flange / 90° Elbow / Slotted ID Cuff

Part Number	A	B	C	WT
M-10-764-350-B5C18	3.5	5	18	7
M-10-764-400-B5.5C18	4	5.5	18	9
M-10-764-500-B8C20	5	8	20	12
M-10-764-600-B9C22	6	9	22	16

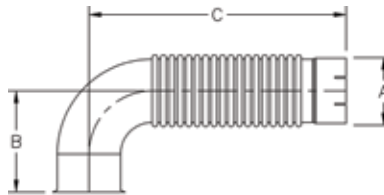

### Machined Turbo Flange / 90° Elbow / Floating ANSI Flange

Part Number	A	B	C	WT
M-10-861F-500-B6.63C23.25	5	6.63	23.25	21
M-10-861F-600-B7.63C24.50	6	7.63	24.50	26

Both 5" and 6" connectors are equipped with a 5" machined turbo flange.

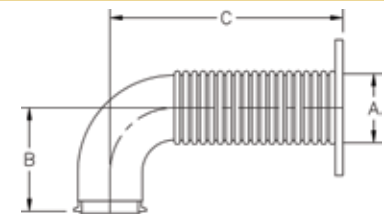

All dimensions are in inches. All weights are in pounds. Weights are approximate. Larger sizes available. All ANSI flanges may be replaced with a standard Caterpillar, Cummins, or MTU engine flanges. Flex is 321 stainless steel. End connections are carbon steel. Connections available in stainless steel.

# M-11 BELLOWS

## Expansion Joints / Bellows

### Floating ANSI Flange / ANSI Flange

Part Number	A	B
M-11-1F1-3512	3.5	12
M-11-1F1-412	4	12
M-11-1F1-512	5	12
M-11-1F1-612	6	12
M-11-1F1-618	6	18
M-11-1F1-812	8	12
M-11-1F1-818	8	18
M-11-1F1-1012	10	12
M-11-1F1-1018	10	18
M-11-1F1-1212	12	12
M-11-1F1-1218	12	18
M-11-1F1-1412	14	12
M-11-1F1-1418	14	18
M-11-1F1-1612	16	12
M-11-1F1-1618	16	18
M-11-1F1-1812	18	12
M-11-1F1-1818	18	18
M-11-1F1-2012	20	12
M-11-1F1-2018	20	18
M-11-1F1-2212	22	12
M-11-1F1-2218	22	18
M-11-1F1-2412	24	12
M-11-1F1-2418	24	18
M-11-1F1-2612	26	12
M-11-1F1-2618	26	18
M-11-1F1-2812	28	12
M-11-1F1-2818	28	18
M-11-1F1-3012	30	12
M-11-1F1-3018	30	18

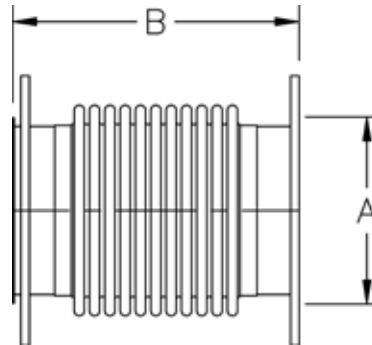

### Male NPT / Male NPT

Part Number	A	B
M-11-22-3514	3.5	14
M-11-22-414	4	14
M-11-22-516	5	16
M-11-22-618	6	18

Threaded pipe nipples may be replaced with plain pipe stubs.

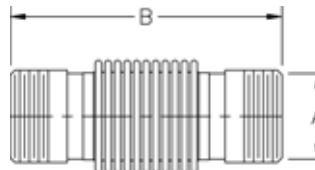

All dimensions are in inches. Other sizes available. All ANSI flanges may be replaced with a standard Caterpillar, Cummins, or MTU engine flanges. Bellows are 321 stainless steel. End connections are carbon steel. Connections available in stainless steel. Bellows flow liners are recommended for exhaust 6" and below when gas/stream flow conditions are greater than available in stainless steel. or equal to 4 ft/second/inch of diameter and for exhaust 8" and above when gas/stream flow conditions are greater than or equal to 25 ft/second.





# M-11 BELLOWS

## Expansion Joints / Bellows

### Female Half Coupling / ANSI Flange

Part Number	A	B
M-11-31-3514	3.5	14
M-11-31-414	4	14
M-11-31-516	5	16
M-11-31-618	6	18

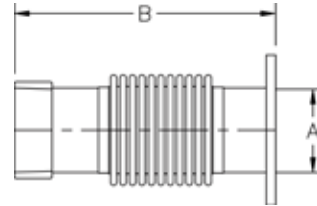

### Slotted ID Cuff / ANSI Flange

Part Number	A	B
M-11-41-3514	3.5	14
M-11-41-414	4	14
M-11-41-514	5	14
M-11-41-618	6	18

Cuff may be replaced by plain tube.

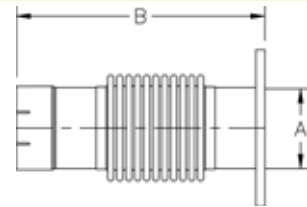

### Slotted ID Cuff / Male NPT

Part Number	A	B
M-11-42-3514	3.5	14
M-11-42-414	4	14
M-11-42-516	5	16
M-11-42-618	6	18

Threaded pipe nipples may be replaced with plain pipe stubs.

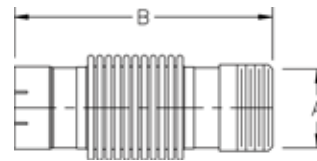

### Slotted ID Cuff / Female Half Coupling

Part Number	A	B
M-11-43-3514	3.5	14
M-11-43-414	4	14

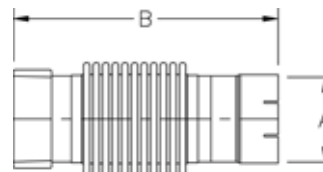

### Slotted ID Cuff / Slotted ID Cuff

Part Number	A	B
M-11-44-3518	3.5	18
M-11-44-418	4	18
M-11-44-518	5	18
M-11-44-618	6	18
M-11-44-818	8	18
M-11-44-1018	10	18
M-11-44-1218	12	18

Tube ends may be substituted.

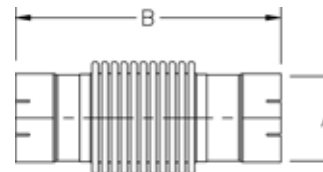

All dimensions are in inches. Other sizes available. All ANSI flanges may be replaced with a standard Caterpillar, Cummins, or MTU engine flanges. Bellows are 321 stainless steel. End connections are carbon steel. Connections available in stainless steel. Bellows flow liners are recommended for exhaust 6" and below when gas/stream flow conditions are greater than available in stainless steel. or equal to 4 ft/second/inch of diameter and for exhaust 8" and above when gas/stream flow conditions are greater than or equal to 25 ft/second.

# M-11 BELLOWS

## Expansion Joints / Bellows

### Floating ANSI Flange / 90° Elbow / Floating ANSI Flange

Part Number	A	B	C
M-11-1F61F-400-B45C16	4	4.5	16
M-11-1F61F-500-B55C16	5	5.5	16
M-11-1F61F-600-B65C18	6	6.5	18
M-11-1F61F-800-B9C18	8	9	18
M-11-1F61F-1000-B11C24	10	11	24
M-11-1F61F-1200-B13C24	12	13	24

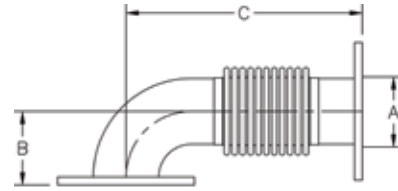

### Floating ANSI Flange / 90° Elbow / Slotted ID Cuff

Part Number	A	B	C
M-11-1F64-400-B45C18	4	4.5	18
M-11-1F64-500-B55C18	5	5.5	18
M-11-1F64-600-B65C20	6	6.5	20

Tube ends may be substituted.

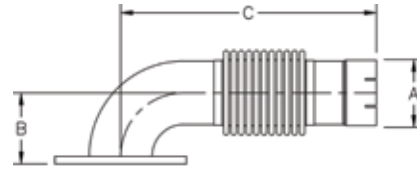

### Flared Flange / 90° Elbow / Floating ANSI Flange

Part Number	A	B	C
M-11-761F-500-B8C18	5	8	18
M-11-761F-600-B9C18	6	9	18

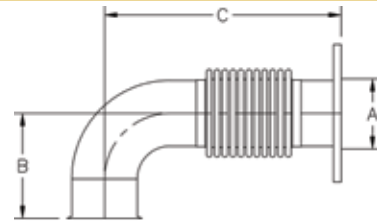

### Flared Flange / 90° Elbow / Slotted ID Cuff

Part Number	A	B	C
M-11-764-350-B5C18	3.5	5	18
M-11-764-400-B5.5C18	4	5.5	18
M-11-764-500-B8C20	5	8	20
M-11-764-600-B9C22	6	9	22

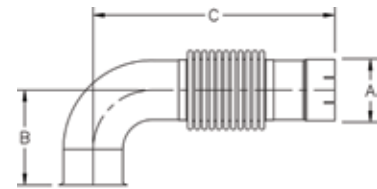

### Machined Turbo Flange / 90° Elbow / Floating ANSI Flange

Part Number	A	B	C
M-11-861F-500-B6.63C18	5	6.63	18
M-11-861F-600-B7.63C18	6	7.63	18
M-11-DD-861F-600-B9.47C20	6	9.47	20

Both 5" and 6" connectors are equipped with a 5" machined turbo flange.

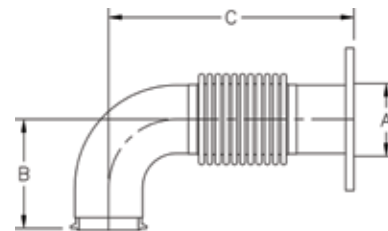

All dimensions are in inches. Other sizes available. All ANSI flanges may be replaced with a standard Caterpillar, Cummins, or MTU engine flanges. Bellows are 321 stainless steel. End connections are carbon steel. Connections available in stainless steel. Bellows flow liners are recommended for exhaust 6" and below when gas/stream flow conditions are greater than available in stainless steel. or equal to 4 ft/second/inch of diameter and for exhaust 8" and above when gas/stream flow conditions are greater than or equal to 25 ft/second.



# M-13 WYES

## Cummins Engine Wyes

### Cummins QST 30

Part Number	Gen Set Model	Size	WT
M-13-3101	DQFAA 750 & DQFAB 800	6 X 6 X 10	57
M-13-3103	DQFAC 900	6 X 6 X 12	69
M-13-3104	DQFAD 1000	6 X 6 X 14	75

Floating Cummins flanged inlets. Floating ANSI flanged outlet.

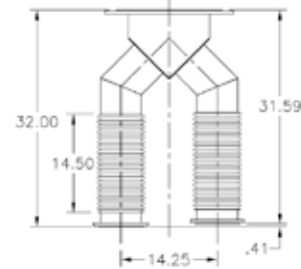

### Cummins QSK 50 (6" Cummins Flanged Inlets)

Part Number	Gen Set Model	Size	WT
M-13-3201	DQKAA 1250	6 X 6 X 12	72
M-13-3202	DQKAB 1250	6 X 6 X 14	78
M-13-3204*	DQKAB 1500	8 X 8 X 14	91

Floating Cummins flanged inlets. Floating ANSI flanged outlet.

\*OAL is 42

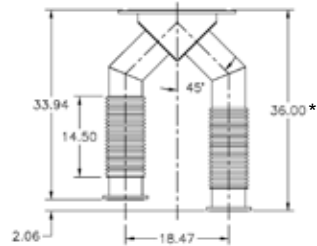

### Cummins QSK 60

Part Number	Gen Set Model	Size	WT
M-13-3301	DQKAA 1750	10 X 10 X 14	157
M-13-3302	DQKAA 1750 & DQKAB 2000	10 X 10 X 16	162
M-13-3304	DQKAB 2000 & DQKH 2250	10 X 10 X 18	163
M-13-3305	DQKAB 2000 & DQKH 2250	10 X 10 X 20	176

Floating ANSI flanged inlets and outlet, unless otherwise noted.

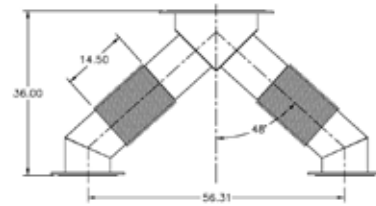

### Cummins QSK 78

Part Number	Gen Set Model	Size	WT
M-13-3401	DQLA 2700 & DQLC 2500	12 X 12 X 18	187
M-13-3402	DQLA 2700 & DQLC 2500	12 X 12 X 20	203
M-13-3403	DQLA 2700 & DQLC 2500	12 X 12 X 22	212
M-13-3404	DQLA 2700 & DQLC 2500	12 X 12 X 24	226

Floating ANSI flanged inlets and outlet, unless otherwise noted.

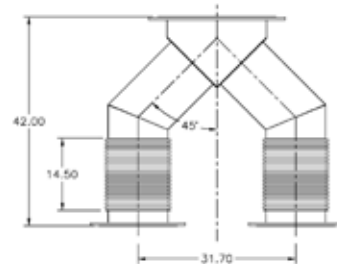

### Cummins QSK95

Part Number	Gen Set Model	Size	WT
M-13-3406	QSK95-69-3000	14 X 14 X 20	208
M-13-3405	QSK95-69-3000	14 X 14 X 22	250

Floating ANSI flanged inlets and outlet, unless otherwise noted.

PLEASE ENSURE FIT AND FUNCTION FOR WYE BEFORE ORDERING.

All dimensions are in inches. All weights are in pounds. Weights are approximate. Larger sizes available. All ANSI flanges may be replaced with a standard Caterpillar, Cummins, or MTU engine flanges. Wyes are carbon steel construction with 321 stainless steel corrugated flex hose. Connections available in stainless steel.

# M-14 WYES

## MTU Engine Wyes

### MTU 2000 Series (650-1000 DSEC, 12V-2000 & 16V-2000)

Part Number	kW	Size	WT
M-14-3131	650 & 750	6 X 6 X 10	70
M-14-3133	900 & 1000	6 X 6 X 12	82

Floating 6" MTU flanged inlets. Floating ANSI flanged outlet.

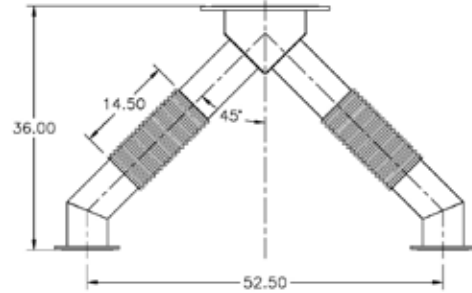

### MTU 4000 Series (12V-4000)

Part Number	kW	Size	WT
M-14-3211	1250, 1350, 1500, & 1750	10 X 10 X 14	118
M-14-3212	1250, 1350, 1500, & 1750	10 X 10 X 16	127

Floating 6" MTU flanged inlets. Floating ANSI flanged outlet.

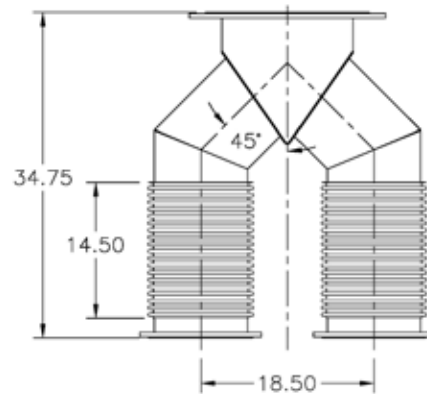

### MTU 4000 Series (16V-4000)

Part Number	kW	Size	WT
M-14-3213	2000	10 X 10 X 16	117
M-14-3214	2000	10 X 10 X 18	118

Floating 6" MTU flanged inlets. Floating ANSI flanged outlet.

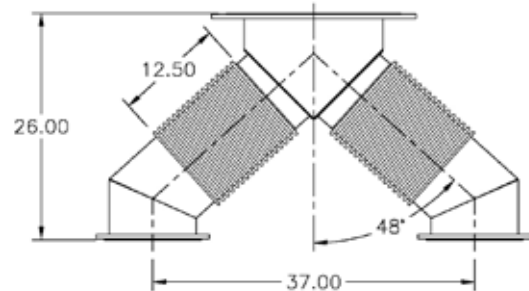

PLEASE ENSURE FIT AND FUNCTION FOR WYE BEFORE ORDERING.

All dimensions are in inches. All weights are in pounds. Weights are approximate. Larger sizes available. All ANSI flanges may be replaced with a standard Caterpillar, Cummins, or MTU engine flanges. Wyes are carbon steel construction with 321 stainless steel corrugated flex hose. Connections available in stainless steel.



# M-15 WYES

## Caterpillar Engine Wyes

### Caterpillar 3508 B (6" CAT Flanged Inlets)

Part Number	kW	Size	WT
M-15-3501	910	8 X 8 X 12	90

Floating CAT flanged inlets and floating ANSI flanged outlet, unless otherwise noted.

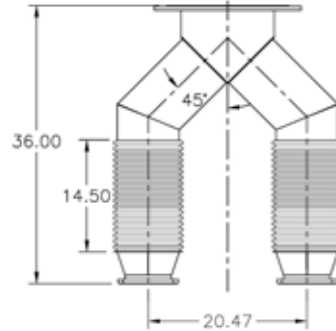

### Caterpillar 3512 C (8" CAT Flanged Inlets)

Part Number	kW	Size	WT
M-15-3512	1275, 1360 & 1400	8 X 8 X 14	102
M-15-3514	1360 & 1400	8 X 8 X 16	113
M-15-3517	1500	10 X 10 X 14	117
M-15-3518	1500	10 X 10 X 16	126

Floating CAT flanged inlets and floating ANSI flanged outlet, unless otherwise noted.

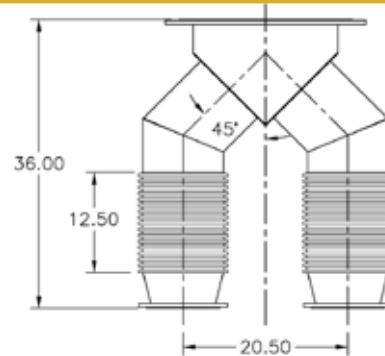

### Caterpillar 3516 C (8" CAT Flanged Inlets)

Part Number	kW	Size	WT
M-15-3551	1640, 1825 & 2000	10 X 10 X 16	126
M-15-3552	1640, 1825 & 2000	10 X 10 X 18	128

Floating CAT flanged inlets and floating ANSI flanged outlet, unless otherwise noted.

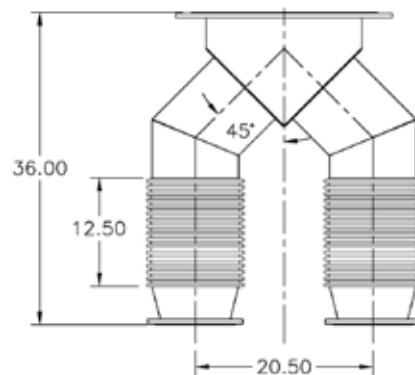

### Caterpillar 3516 Quad Turbo (8" CAT Flanged Inlets)

Part Number	kW	Size	WT
M-15-3571	1640	10 X 10 X 14	117
M-15-3551	1640 & 1750	10 X 10 X 16	126
M-15-3552	1750	10 X 10 X 18	128
M-15-3572	2000	10 x 10 x 20	140

Floating CAT flanged inlets and floating ANSI flanged outlet, unless otherwise noted.

PLEASE ENSURE FIT AND FUNCTION FOR WYE BEFORE ORDERING.  
 All dimensions are in inches. All weights are in pounds. Weights are approximate. Larger sizes available. All ANSI flanges may be replaced with a standard Caterpillar, Cummins, or MTU engine flanges. Wyes are carbon steel construction with 321 stainless steel corrugated flex hose. Connections available in stainless steel.

# M-20 THIMBLES

## Wall and Roof Thimbles

### Type A (Combustible Walls Only)

Part Number	A	B	WT
M-20-A-200	2	14	52
M-20-A-238	2.38	15	53
M-20-A-250	2.5	15	53
M-20-A-288	2.88	15	57
M-20-A-300	3	15	57
M-20-A-350	3.5	16	58
M-20-A-400	4	16	66
M-20-A-450	4.5	17	68
M-20-A-500	5	17	88
M-20-A-556	5.56	18	90
M-20-A-600	6	18	98
M-20-A-663	6.63	19	100
M-20-A-800	8	20	114
M-20-A-863	8.63	21	117
M-20-A-1000	10	22	130
M-20-A-1075	10.75	23	136
M-20-A-1200	12	24	146
M-20-A-1275	12.75	25	150
M-20-A-1400	14	26	159
M-20-A-1600	16	28	175
M-20-A-1800	18	30	218

### Type B (Roof & Non-Combustible Walls)

Part Number	A	B	WT
M-20-B-200	2	9	38
M-20-B-238	2.38	9	39
M-20-B-250	2.5	9	39
M-20-B-288	2.88	10	43
M-20-B-300	3	10	43
M-20-B-350	3.5	10	44
M-20-B-400	4	11	46
M-20-B-450	4.5	11	49
M-20-B-500	5	12	60
M-20-B-556	5.56	12	61
M-20-B-600	6	13	69
M-20-B-663	6.63	13	70
M-20-B-800	8	15	84
M-20-B-863	8.63	15	86
M-20-B-1000	10	17	104
M-20-B-1075	10.75	17	108
M-20-B-1200	12	19	117
M-20-B-1275	12.75	19	121
M-20-B-1400	14	20	131
M-20-B-1600	16	22	145
M-20-B-1800	18	26	180

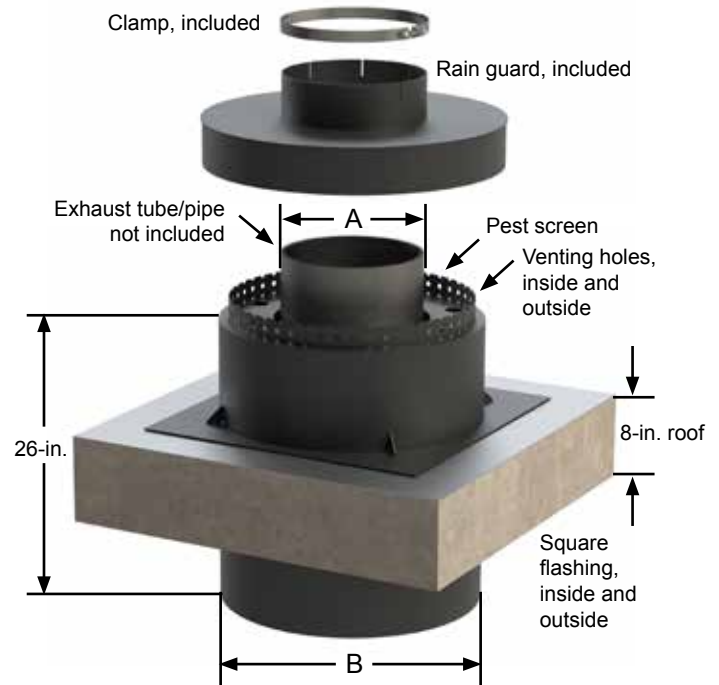

### OD Measurement of Standard Schedule Pipe

Nominal Pipe Size	OD (Thimble "A" Dim)
2	2.38
2.5	2.88
3	3.50
4	4.50
5	5.56
6	6.63
8	8.63
10	10.75
12	12.75
14	14

"A" Dimension measures the outside diameter of the exhaust tube or pipe. See chart above for outside diameter of standard pipe.

All dimensions are in inches. All weights are in pounds. Weights are approximate. Carbon steel construction. Available in stainless steel. When calculating height thimble must have a 9" clearance on each side of the wall or roof. To prevent warping, outer flashing is not welded 100%. Be sure to include correct roof pitch on all roof applications. There is an additional charge for non-flat roof applications. Conforms to NFPA 37 and 110. Thimbles have been sized for standard (8") thick walls and roofs. Thermal barrier used within the thimbles is composed of high density, type "E" fibers, fibrous glass heavy-duty insulation. Please apply high-temp silicone caulking where needed. Pest Control Screen adds 2"-3" to exterior height.



# M-21 ROOF JACKS

## Roofs Jacks

### Rainguards (Cuffed)

Part Number	A	B	C
M-21-C-400	4	5	7
M-21-C-450	4.5	5.5	7.5
M-21-C-500	5	6	8
M-21-C-556	5.56	6.5	8.5
M-21-C-600	6	7	9
M-21-C-663	6.63	7.8	10
M-21-C-800	8	9	11
M-21-C-863	8.63	9.8	12
M-21-C-1000	10	11	13
M-21-C-1075	10.75	12	14
M-21-C-1200	12	13	15
M-21-C-1275	12.75	14	16

Clamp included. Roof jacks are designed for non-combustible metal enclosures only.

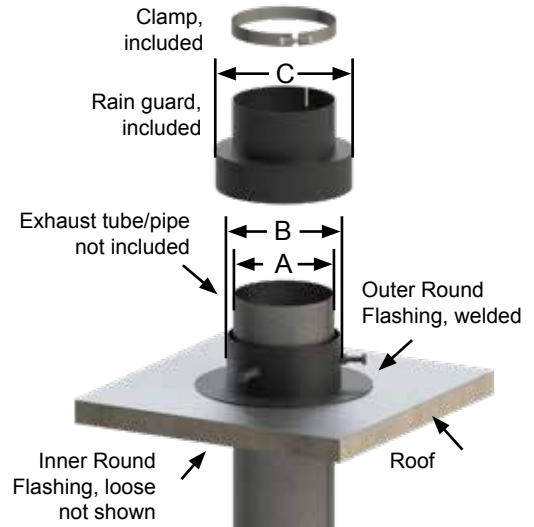

### Rainguards (Flanged)

Part Number	A	B	C
M-21-F-400	4	5	15
M-21-F-450	4.5	5.5	15
M-21-F-500	5	6	15
M-21-F-556	5.56	6.5	15
M-21-F-600	6	7	15
M-21-F-663	6.63	7.8	15
M-21-F-800	8	9	18
M-21-F-863	8.63	9.8	18
M-21-F-1000	10	11	20
M-21-F-1075	10.75	12	20
M-21-F-1200	12	13	24
M-21-F-1275	12.75	14	24

Roof jacks are designed for non-combustible metal enclosures only.

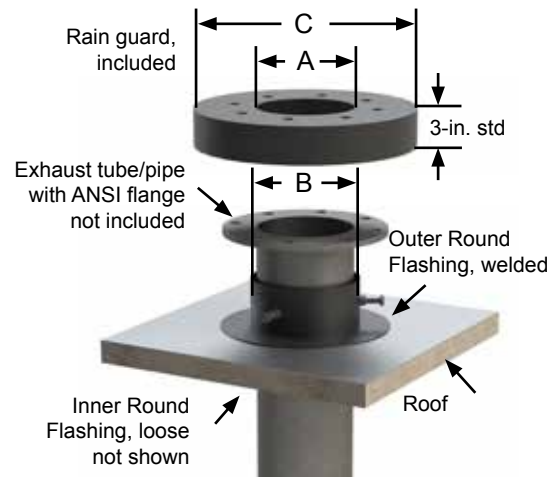

CAUTION: Roof jacks are designed for non-combustible metal enclosures only. Avoid potential fire hazard. Product should never be exposed to combustible material. DO NOT USE if combustible materials are present. Refer to Wall and Roof Thimbles for applications where combustible materials will come in contact with the product. All dimensions are in inches. Larger sizes available. Available in stainless steel.

# M-22 RAIN CAPS

## Rain Caps

### Standard (Carbon Steel)

Part Number	ID (Collar)
M-22-100	1
M-22-150	1.5
M-22-200	2
M-22-238	2.38
M-22-250	2.5
M-22-288	2.88
M-22-300	3
M-22-350	3.5
M-22-400	4
M-22-450	4.5
M-22-500	5
M-22-556	5.56
M-22-600	6
M-22-663	6.63
M-22-800	8



Recommended for both horizontal and vertical installation.

### Heavy Duty (Carbon Steel)

Part Number	ID (Collar)	Weight
M-22-700-HD	7	5
M-22-800-HD	8	5
M-22-863-HD	8.63	6
M-22-900-HD	9	6
M-22-1000-HD	10	7
M-22-1075-HD	10.75	8
M-22-1200-HD	12	9
M-22-1275-HD	12.75	10
M-22-1400-HD	14	26
M-22-1600-HD	16	29
M-22-1800-HD	18	43
M-22-2000-HD	20	64
M-22-2200-HD	22	72
M-22-2400-HD	24	84
M-22-2600-HD	26	88
M-22-2800-HD	28	94
M-22-3000-HD	30	99



Recommended for vertical installation only.

All dimensions are in inches. All weights are in pounds. Weights are approximate. Other sizes available.





# M-22 RAIN CAPS

## Stainless Steel Rain Caps

### Standard (304 Stainless Steel)

Part Number	ID (Collar)
-------------	-------------

M-22-200-S	2
M-22-250-S	2.5
M-22-300-S	3
M-22-350-S	3.5
M-22-400-S	4
M-22-450-S	4.5
M-22-500-S	5
M-22-556-S	5.56
M-22-600-S	6
M-22-663-S	6.63
M-22-800-S	8

Recommended for vertical installation only.



### Heavy Duty (304 Stainless Steel)

Part Number	ID (Collar)	Weight
-------------	-------------	--------

M-22-863-S	8.63	6
M-22-1000-S	10	7
M-22-1075-S	10.75	8
M-22-1200-S	12	9
M-22-1275-S	12.75	10
M-22-1400-S	14	26
M-22-1600-S	16	29
M-22-1800-S	18	43
M-22-2000-S	20	64
M-22-2200-S	22	72
M-22-2400-S	24	84

Recommended for vertical installation only.



# M-23 to M-24 ELBOWS

## Elbows

### 90° Tube Elbow (Short Radius), Flanged One End

Part Number	A	B	C	WT
M-23-400	4	4.38	7.5	9
M-23-500	5	5.25	9	11
M-23-600	6	6.25	11	14
M-23-800	8	8	12	26
M-23-1000	10	10	14	-
M-23-1200	12	12	16	-

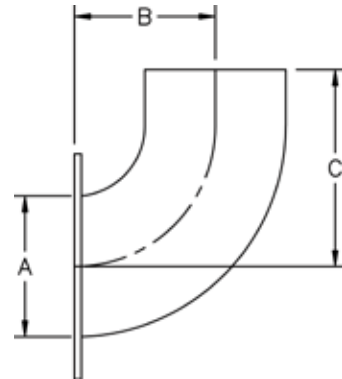

### 90° Mitered Elbow (Short Radius), Flanged One End

Part Number	A	B	C	WT
M-24-800	8	8	8	22
M-24-1000	10	10	10	31
M-24-1200	12	12	12	45
M-24-1400	14	14	14	55
M-24-1600	16	16	16	81
M-24-1800	18	18	18	94
M-24-2000	20	20	20	114
M-24-2200	22	22	22	133
M-24-2400	24	24	24	158
M-24-2600	26	26	26	183
M-24-2800	28	28	28	208
M-24-3000	30	30	30	387

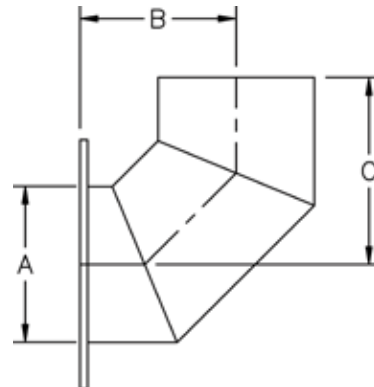

All dimensions are in inches. All weights are in pounds. Weights are approximate. Larger sizes available. Available in stainless steel. Connection(s) are ANSI steel plate flanges unless otherwise specified.



# M-25 OUTLET EXTENSIONS

## Assembled Tubing

### Straight Tube (Stacks), Flanged One End

Part Number	A (OD)	B
M-25-400-1	4	12
M-25-450-1	4.5	12
M-25-500-1	5	15
M-25-600-1	6	18
M-25-800-1	8	18
M-25-1000-1	10	20
M-25-1200-1	12	24
M-25-1400-1	14	28
M-25-1600-1	16	32
M-25-1800-1	18	36
M-25-2000-1	20	40
M-25-2200-1	22	44
M-25-2400-1	24	48
M-25-2600-1	26	48
M-25-2800-1	28	48
M-25-3000-1	30	48

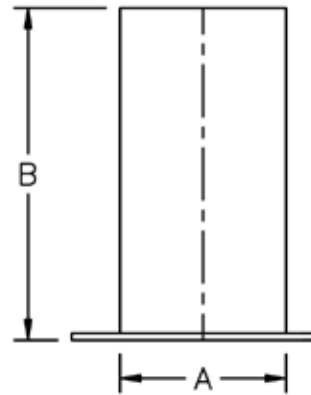

### Straight Tube, 45° Cut with Bird Screen

Part Number	A (OD)	B
M-25-400-2	4	12
M-25-450-2	4.5	12
M-25-500-2	5	15
M-25-600-2	6	18
M-25-800-2	8	18
M-25-1000-2	10	20
M-25-1200-2	12	24
M-25-1400-2	14	28
M-25-1600-2	16	32
M-25-1800-2	18	36
M-25-2000-2	20	40
M-25-2200-2	22	44
M-25-2400-2	24	48
M-25-2600-2	26	48
M-25-2800-2	28	48
M-25-3000-2	30	48

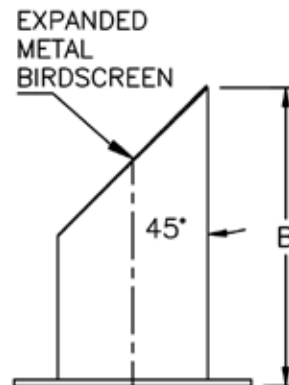

All dimensions are in inches. All weights are in pounds. Weights are approximate. Larger sizes available. Available in stainless steel. Connection(s) are ANSI steel plate flanges unless otherwise specified.

# M-25 to M-26 OUTLET EXTENSIONS

## Assembled Tubing and 90° Elbows

### Straight Tube, Flanged Both Ends

Part Number	Length	A (OD)	B	WT
M-25-11-400-12	12	4	12	16
M-25-11-450-12	12	4.5	12	16
M-25-11-500-15	15	5	15	23
M-25-11-600-18	18	6	18	25
M-25-11-800-18	18	8	18	38
M-25-11-1000-20	20	10	20	50
M-25-11-1200-24	24	12	24	72
M-25-11-1400-28	28	14	28	87
M-25-11-1600-32	32	16	32	108
M-25-11-1800-36	36	18	36	134
M-25-11-2000-40	40	20	40	166
M-25-11-2200-48	48	22	48	201
M-25-11-2400-48	48	24	48	226
M-25-11-2600-48	48	26	48	247
M-25-11-2800-48	48	28	48	268
M-25-11-3000-48	48	30	48	436

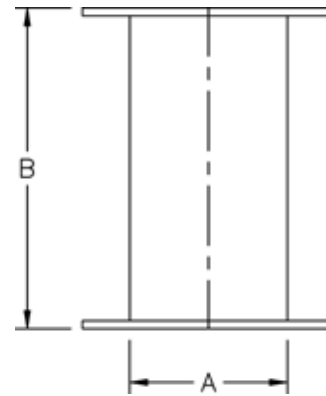

### 90° Elbow (Short Radius), Tube, Flanged Both Ends

Part Number	A	B	C	WT
M-26-400	4	7.5	7.5	16
M-26-500	5	9	9	20
M-26-600	6	11	11	24
M-26-800	8	12	12	39
M-26-1000	10	14	14	53
M-26-1200	12	16	16	75

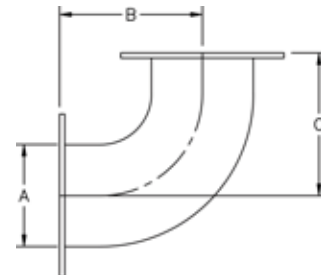

### 90° Elbow (Short Radius), Mitered, Flanged Both Ends

Part Number	A	B	C	WT
M-26-M-800	8	8	8	34
M-26-M-1000	10	10	10	47
M-26-M-1200	12	12	12	67
M-26-M-1400	14	14	14	80
M-26-M-1600	16	16	16	111
M-26-M-1800	18	18	18	124
M-26-M-2000	20	20	20	150
M-26-M-2200	22	22	22	171
M-26-M-2400	24	24	24	203
M-26-M-2600	26	26	26	232
M-26-M-2800	28	28	28	262
M-26-M-3000	30	30	30	447

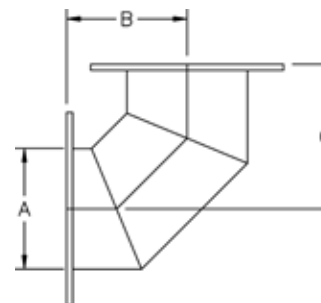

All dimensions are in inches. All weights are in pounds. Weights are approximate. Larger sizes available. Available in stainless steel. Connection(s) are ANSI steel plate flanges unless otherwise specified.



# M-27 PIPE HANGERS

## Pipe Hangers

### Pipe Hangers, Clevis

Part Number	Pipe Size	A	B	C	D	Bolt Size
M-27-1-150	2	4.5	0.38	3.0	1.63	0.25
M-27-1-200	2	4.63	0.38	2.94	1.31	0.25
M-27-1-250	3	6	0.50	3.88	1.75	0.38
M-27-1-300	3	6.69	0.50	4.25	1.75	0.38
M-27-1-350	4	7.19	0.50	4.56	1.75	0.38
M-27-1-400	4	8.19	0.63	5.06	2.06	0.38
M-27-1-500	5	9.5	0.63	5.88	2.06	0.50
M-27-1-600	6	10.69	0.75	6.31	2.25	0.50
M-27-1-800	8	13.75	0.88	8.38	2.50	0.63
M-27-1-1000	10	16.44	0.88	9.88	2.50	0.75
M-27-1-1200	12	18.63	0.88	11.06	2.94	0.75
M-27-1-1400	14	20.88	1.0	12.44	3.19	0.88
M-27-1-1600	16	23.31	1.0	13.88	3.19	0.88
M-27-1-1800	18	25.25	1.0	14.69	2.94	0.88
M-27-1-2000	20	29.31	1.25	17.38	4.19	1.00
M-27-1-2400	24	33.19	1.5	19.63	3.75	1.00

Heavy plate steel construction.

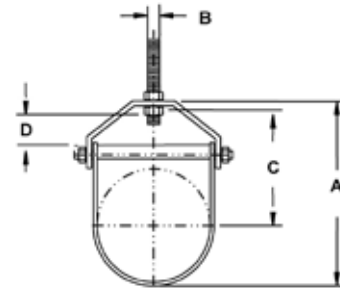

### Pipe Hangers, Pear Shaped

Part Number	Pipe Size	A	B	C	D
M-27-2-150	1.5	0.38	2.88	2.0	1.0
M-27-2-200	2	0.38	3.31	2.44	1.25
M-27-2-250	2.5	0.50	3.94	2.94	1.5
M-27-2-300	3	0.50	4.25	3.25	1.5
M-27-2-400	4	0.63	5.75	4.25	2.0
M-27-2-500	5	0.63	6.31	4.81	2.06
M-27-2-600	6	0.75	6.88	5.38	0.06
M-27-2-800	8	0.88	8.56	6.94	2.63

Adjustable.

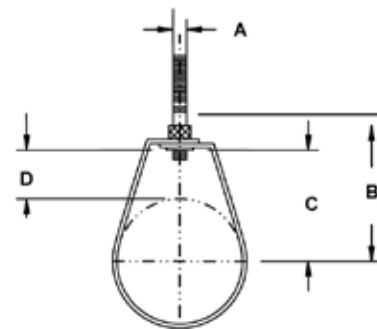

# M-29 BRACKETS

## Round Mounting Brackets

### Single Piece Construction, Carbon Steel

Part Number	A	B	C	F	G	T	WT
M-29-400	4.00	2.25	0.38	1.00	2.62	0.13	0.50
M-29-450	4.50	2.50	0.38	1.00	2.86	0.13	0.60
M-29-500	5.00	3.50	0.38	1.00	3.12	0.13	0.70
M-29-550	5.50	3.00	0.38	1.00	3.33	0.13	0.70
M-29-600	6.00	3.00	0.38	1.00	3.56	0.13	0.80
M-29-650	6.50	3.75	0.38	1.00	3.83	0.13	0.80
M-29-700	7.00	4.50	0.38	1.00	4.06	0.13	1.00
M-29-800	8.00	4.25	0.38	1.25	5.00	0.13	1.50
M-29-850	8.50	4.25	0.38	1.25	5.25	0.13	1.50
M-29-900	9.00	4.50	0.38	1.25	5.50	0.13	1.70
M-29-1000	10.00	5.00	0.38	1.25	6.00	0.13	1.70
M-29-1100	11.00	5.00	0.38	1.25	6.50	0.13	1.80
M-29-1200	12.00	5.00	0.38	1.25	7.00	0.13	2.00
M-29-1400	14.00	6.00	0.41	1.25	8.12	0.13	3.00

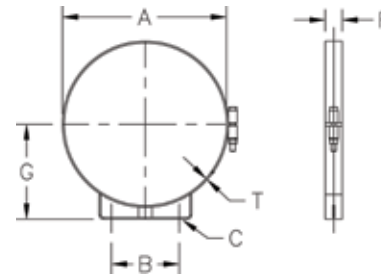

### Two-Piece Split Design, Carbon Steel

Part Number	A	B	C	F	G	T	WT
M-29-1600	16	8	0.50	2.0	8.9	0.134	5.5
M-29-1800	18	9	0.50	2.0	11.12	0.134	6
M-29-2000	20	10	0.50	2.5	12.06	0.134	9.5
M-29-2200	22	11	0.50	2.5	13.63	0.134	10.5
M-29-2400	24	12	0.63	2.5	14.56	0.134	11.5
M-29-2600	26	13	0.63	3.0	15.44	0.190	17.5
M-29-2800	28	14	0.63	3.0	16.31	0.190	24
M-29-3000	30	15	0.63	4.0	17.25	0.190	27
M-29-3600	36	18	0.63	4.0	20.12	0.190	33
M-29-4000	40	20	0.75	4.0	22.38	0.190	40
M-29-4200	42	21	0.75	4.0	23.38	0.190	44
M-29-4500	45	22.5	1.0	4.0	25.19	0.190	50
M-29-4800	48	24	1.0	4.0	26.50	0.250	63
M-29-5000	50	25	1.0	4.0	29.00	0.250	65
M-28-5400	54	27	1.0	4.0	30.50	0.250	67
M-29-6000	60	30	1.0	6.0	34.50	0.250	118
M-29-6200	62	32.0	1.0	6.0	35.00	0.250	120

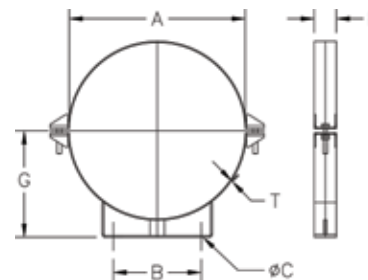

M-29 Brackets are NOT be used for vertical installations, we recommend the installation of WELDED SERIES BRACKETS (found in Silencer Catalog)

M-29 brackets are NOT recommended to hang a pipe or silencer.

All dimensions are in inches. All weights are in pounds. Weights are approximate. Larger sizes available. Available in stainless steel.



# M-31 to M-35 CLAMPS

## Circle, Round Bolt, Seal, and V-Band Clamps

### Full Circle, Carbon Steel

Part Number	Size	Part Number	Size	Part Number	Size
M-31-300	3	M-31-600	6	M-31-1200	12
M-31-350	3.50	M-31-663	6.63	M-31-1275	12.75
M-31-400	4	M-31-800	8	M-31-1400	14
M-31-450	4.50	M-31-863	8.63	M-31-1600	16
M-31-500	5	M-31-1000	10		
M-31-550	5.50	M-31-1075	10.75		

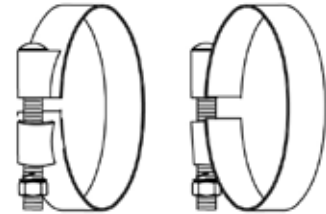

Not available in stainless steel, see M-33 for stainless steel alternative.

### Round Bolt, Carbon Steel

Part Number	Size	Bolt Size	Part Number	Size	Bolt Size
M-32-200	2	0.31	M-32-450	4.5	0.38
M-32-225	2.25	0.31	M-32-500	5	0.38
M-32-250	2.5	0.31	M-32-550	5.5	0.38
M-32-300	3	0.31	M-32-600	6	0.38
M-32-350	3.5	0.38	M-32-800	8	0.50
M-32-400	4	0.38	M-32-1000	10	0.50

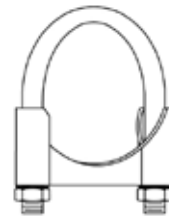

### Seal, Stainless Steel

Part Number	Size	Part Number	Size
M-33-200	2	M-33-450	4.5
M-33-225	2.25	M-33-500	5
M-33-250	2.5	M-33-600	6
M-33-300	3	M-33-800	8
M-33-350	3.5	M-33-1000	10
M-33-400	4	M-33-1200	12

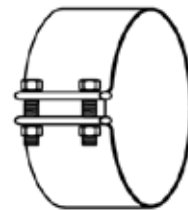

### Stainless V-Band Manifold

Part Number	Tube Size	Apex	Diameter	H	Application
M-35-JD-400	4	0.207	4.81	0.28	John Deere
M-35-400	4	0.406	4.75	0.28	Cummins L10
M-35-401	4	0.207	4.81	0.28	Detroit 6-71, 12V71
M-35-402	4	0.156	4.61	0.10	Airesearch TEO699
M-35-450	4.5	0.262	5.25	0.14	AIR T7899, TH08A64
M-35-500	5	0.400	5.88	0.28	Cummins VT50
M-35-501	5	0.262	5.65	0.14	CAT Turbo
M-35-502	5	0.280	5.92	0.30	Detroit Diesel
M-35-550	5.5	0.265	6.25	0.15	16V-2000 (1000kW)

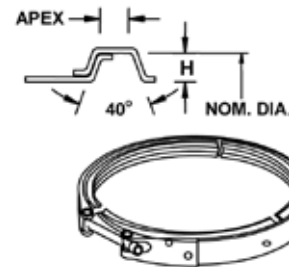

All dimensions are in inches. Larger sizes available. Stainless steel available.

# M-36 to M-40 FLANGES

## Flared, Machine Turbo, and Engine Flanges

### Flared

Part Number	ID	OD	Length	V-Band Clamp
M-36-JD-250	2.5	3.13	3	35-JD-250
M-36-300	3	3.63	1.5	Call
M-36-350	3.5	4.25	1.5	Call
M-36-JD-400	3.9	4.41	3	35-JD-400
M-36-400	4	4.63	1.5	35-400
M-36-500	5	5.75	3	35-500
M-36-600	6	6.5	3	Call

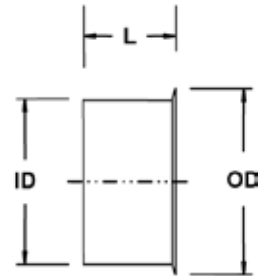

### Machined Turbo (From 1018 Heavy Wall Tubing)

Part Number	Nom. Size	A	B	Clamp	Application
M-37-450	5	4.5	5	35-450	See Footnote†
M-37-550	6	5.3	6.2	35-550	DA 16V2000

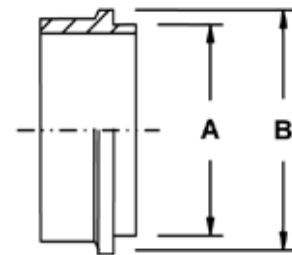

### Standard Engine (Caterpillar, MTU, Cummins)

Part Number	Engine	Type	A (ID)	B (OD)	C (BC)	D (DIA)	Holes	E (THK)	WT
M-38-340	CAT	1	3	5.5	4.13	0.56	4	0.5	3
M-38-400	CAT	1	4.1	5.5	4.13	0.56	4	0.5	2
M-38-500	CAT	1	5.1	6.5	5	0.75	4	0.5	3
M-38-600	CAT	1	6.1	7.75	6	0.75	4	0.5	4
M-38-800	CAT	2	8.1	11	9.88	0.5	8	0.5	6
M-38-1000	CAT	2	10.1	13.5	12.44	0.5	12	0.5	9
M-38-1000-3516ULB	CAT	2	10.13	14	12.6	0.56	12	0.5	10
M-38-1200	CAT	2	12.1	16	14.8	0.5	12	0.5	12
M-38-1400	CAT	2	14.2	18.5	16.93	0.63	12	0.5	15
M-38-1800	CAT	2	18.12	22.51	20.88	0.62	16	0.5	19
M-39-600	MTU	2	6.06	9.5	8.19	0.44	6	0.5	5
M-39-800	MTU	2	8.1	11	9.88	0.5	8	0.5	6
M-39-1000	MTU	2	10	13	11.88	0.63	8	0.5	7
M-40-600	CUM	2	6.1	8	7.19	0.44	8	0.5	3

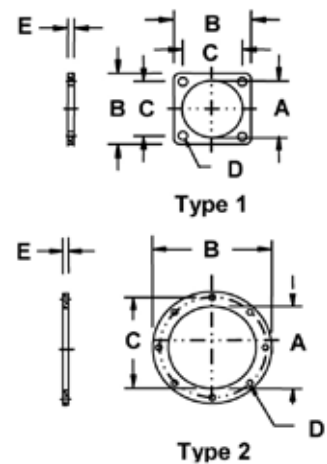

All dimensions are in inches. All weights are in pounds. Weights are approximate. Larger sizes available. † 37-450 used on the following engines: Airesearch TV801, T1885, T18A40, All Schwitzer, DDA Turbo, and Cummins K.





# M-41 FLANGES

## ANSI Pattern Flanges

**ANSI Pattern Steel Plate, Carbon Steel**

Part Number	Pipe/Tube	A (ID)	B (OD)	C (BC)	D (DIA)	Holes	E (THK)	WT
M-41-T-200	Tube	2.00	6.0	4.75	0.75	4	0.5	3.2
M-41-P-200	Pipe	2.38	6.0	4.75	0.75	4	0.5	3
M-41-T-250	Tube	2.50	7.0	5.50	0.75	4	0.5	4.2
M-41-P-250	Pipe	2.88	7.0	5.50	0.75	4	0.5	4
M-41-T-300	Tube	3.00	7.5	6.00	0.75	4	0.5	4.7
M-41-P-300	Pipe	3.50	7.5	6.00	0.75	4	0.5	5.2
M-41-T-350	Tube	3.50	8.5	7.00	0.75	8	0.5	5.5
M-41-P-350	Pipe	4.00	8.5	7.00	0.75	8	0.5	5.5
M-41-400	Tube	4.00	9.0	7.50	0.75	8	0.5	7
M-41-450	Pipe	4.50	9.0	7.50	0.75	8	0.5	6
M-41-500	Tube	5.00	10.0	8.50	0.88	8	0.5	7.5
M-41-556	Pipe	5.56	10.0	8.50	0.88	8	0.5	7
M-41-600	Tube	6.00	11.0	9.50	0.88	8	0.5	8.5
M-41-663	Pipe	6.63	11.0	9.50	0.88	8	0.5	7.5
M-41-800	Tube	8.00	13.5	11.75	0.88	8	0.5	12.5
M-41-863	Pipe	8.63	13.5	11.75	0.88	8	0.5	11
M-41-1000	Tube	10.00	16.0	14.25	1.00	12	0.5	18
M-41-1075	Pipe	10.75	16.0	14.25	1.00	12	0.5	17
M-41-1200	Tube	12.00	19.0	17.00	1.00	12	0.5	21
M-41-1275	Pipe	12.75	19.0	17.00	1.00	12	0.5	20
M-41-1400	Tube	14.10	21.0	18.75	1.13	12	0.5	24
M-41-1600	Tube	16.10	23.5	21.25	1.13	16	0.5	28
M-41-1800	Tube	18.10	25.0	22.75	1.25	16	0.5	30
M-41-2000	Tube	20.10	27.5	25.00	1.25	20	0.5	34
M-41-2200	Tube	22.10	29.5	27.25	1.38	20	0.5	36
M-41-2400	Tube	24.10	32.0	29.50	1.38	20	0.5	38
M-41-2600	Tube	26.10	34.3	31.75	1.38	24	0.5	43
M-41-2800	Tube	28.10	36.5	34.00	1.38	28	0.5	49
M-41-3000	Tube	30.10	38.8	36.00	1.38	28	0.5	55
M-41-3600	Tube	36.00	46.0	42.8	1.6	32	0.5	80

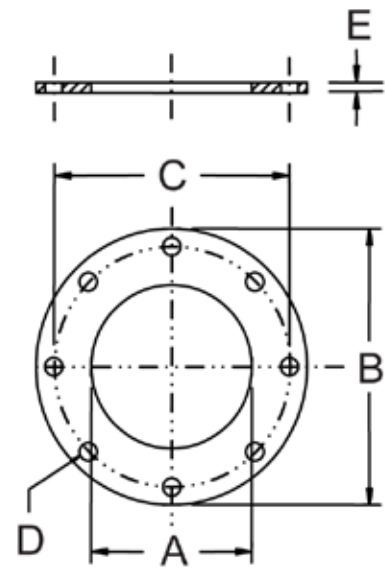

All dimensions are in inches. All weights are in pounds. Weights are approximate. Larger sizes available.

# M-45 to M-46 FLANGES

## Threaded Flat Face and Reducing / Increasing Flanges

### ANSI Threaded Flat Face

Part Number	Thread Size	BC Diameter
M-45-150	1.5	3.9
M-45-200	2	4.8
M-45-250	2.5	5.5
M-45-300	3	6.0
M-45-350	3.5	7.0
M-45-400	4	7.5
M-45-500	5	8.5
M-45-600	6	9.5
M-45-800	8	11.8

NPT Standard Pipe Threads.

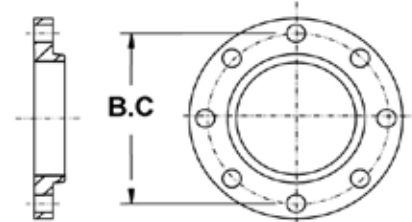

### ANSI Reducing / Increasing

Part Number Pipe	Part Number Tube	Reducing Size	IPS Size	BC Diameter	WT
M-46-P-430	M-46-T-430	4 x 3	3.0	7.50	8
M-46-P-435	M-46-T-435	4 x 3.5	3.5	7.50	8
M-46-P-535	M-46-T-535	5 x 3.5	3.5	8.50	9
M-46-P-540	M-46-T-540	5 x 4	4.0	8.50	9
M-46-P-640	M-46-T-640	6 x 4	4.0	9.50	11
M-46-P-650	M-46-T-650	6 x 5	5.0	9.50	10
M-46-P-840	M-46-T-840	8 x 6	4.0	11.75	18
M-46-P-850	M-46-T-850	8 x 5	5.0	11.75	17
M-46-P-860	M-46-T-860	8 x 6	6.0	11.75	16
M-46-P-1060	M-46-T-1060	10 x 6	6.0	14.25	23
M-46-P-1080	M-46-T-1080	10 x 8	8.0	14.25	19
M-46-P-1280	M-46-T-1280	12 x 8	8.0	17.00	32
M-46-P-1210	M-46-T-1210	12 x 10	10.0	17.00	28
M-46-P-1480	M-46-T-1480	14 x 8	8.0	18.75	39
M-46-P-1410	M-46-T-1410	14 x 10	10.0	18.75	36
M-46-P-1412	M-46-T-1412	14 x 12	12.0	18.75	31

Flanges (.50") thick carbon steel plate.

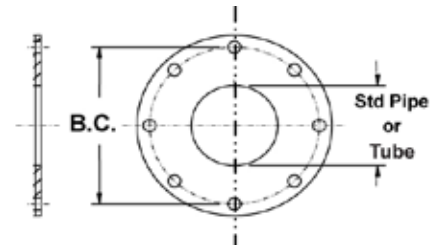

All dimensions are in inches. All weights are in pounds. Weights are approximate. Larger sizes available. Available in stainless steel.



# M-47 to M-48 GASKET SPECIFICATIONS

## Gaskets - Technical Specifications

### Fiber Full Face Gaskets, Temperature Rating: 1800° F

Physical Test Properties	Specification Range	Nominal Test Values	Test Method
Compression @ 34.5 MPa (5000psi)	25-40%	35%	ASTM F-806
Recovery @ 34.5 MPa (5000 psi)	30% Min	34%	ASTM F-806
Ignition Loss (1 hour @ 1500° F)	30% Max	27%	ASTM F-495
Air Aging 70 hrs @ 540° C (1000° F) Thickness Loss	0-10%	6%	ASTM D-573
Air Aging 70 hrs @ 540° C (1000° F) Weight Loss	20% Max	11%	

### Fluid Immersions (22 hours @ 78° - 85° F)

Fluid Resistance ASTM IRM903 Oil - Thickness Change	12-20%	12%	ASTM F-146
Fluid Resistance ASTM IRM903 Oil - Weight Change	70% ▲ Max.	58%	ASTM F-146
Fluid Resistance ASTM Fuel B - Thickness Change	10-20%	15%	ASTM F-146
Fluid Resistance ASTM Fuel B - Weight Change	50% ▲ Max.	45%	ASTM F-146

Fiber full face gaskets use a 0.008" ETP (electrolytic tin plate) low carbon steel core. The core is then laminated on two sides with a facing composed of heat resistant vermiculite and ceramic fibers chemically bonded with an NBR binder. This gasket is designed for hot gas applications where extreme heat is present. The fiber facings are mechanically bonded without the use of any adhesives, providing stability and integrity even when exposed to high heat, scrubbing, and vibration. Gasket is asbestos-free. Its color is light brown.

# M-47 and M-47L NBG KITS

## Nut Bolt Gasket Kits

### Fiber Full Face Engine Gasket Kits (1 gasket per set)

Part Number	Engine	Size	Bolt		Bolts/Nuts per Set
			Diameter	Length	
M-47-CAT-400-FF	CAT	4	0.50	2	4
M-47-CAT-500-FF	CAT	5	0.625	2	4
M-47-CAT-600-FF	CAT	6	0.625	2	4
M-47-CAT-800-FF	CAT	8	0.375	2	8
M-47-CAT-1000-FF	CAT	10	0.375	2	12
M-47-CAT-1000-51001	CAT	10	0.50	2	12
M-47-CAT-1200-FF	CAT	12	0.375	2	12
M-47-CAT-1400-FF	CAT	14	0.50	2	12
M-47-CUM-600-FF	CUM	6	0.375	2	8
M-47-MTU-600-FF	MTU	6	0.375	2	6
M-47-MTU-800-FF	MTU	8	0.375	2	8
M-47-MTU-1000-FF	MTU	10	0.50	2	8

Grade 2 Zinc plated nuts/bolts. Available in 304 and 316 stainless steel.  
 Fiber gasket rated up to 1,800° F for continuous use, 2,300° F maximum temperature.  
 One (1) gasket per set.



### Fiber Full Face Gasket Kits (1 gasket per set)

Standard	Bolt		Bolt/Nuts	Bolt	Long	Bolt
Part Number	Size	Diameter	per Set	Length	Part Number	Length
M-47-FF-200	2	0.625	4	2	M-47L-FF-200	3
M-47-FF-250	2.5	0.625	4	2	M-47L-FF-250	3
M-47-FF-300	3	0.625	4	2	M-47L-FF-300	3
M-47-FF-350	3.5	0.625	8	2	M-47L-FF-350	3
M-47-FF-400	4	0.625	8	2	M-47L-FF-400	3
M-47-FF-500	5	0.75	8	2	M-47L-FF-500	3
M-47-FF-600	6	0.75	8	2	M-47L-FF-600	3
M-47-FF-800	8	0.75	8	2	M-47L-FF-800	3
M-47-FF-1000	10	0.875	12	2.5	M-47L-FF-1000	3.5
M-47-FF-1200	12	0.875	12	2.5	M-47L-FF-1200	3.5
M-47-FF-1400	14	1.00	12	2.5	M-47L-FF-1400	3.5
M-47-FF-1600	16	1.00	16	2.5	M-47L-FF-1600	3.5
M-47-FF-1800	18	1.125	16	3	M-47L-FF-1800	4
M-47-FF-2000	20	1.125	20	3	M-47L-FF-2000	4
M-47-FF-2200	22	1.250	20	3	M-47L-FF-2200	4
M-47-FF-2400	24	1.250	20	3	M-47L-FF-2400	4
M-47-FF-2600	26	1.250	24	3	M-47L-FF-2600	4
M-47-FF-2800	28	1.250	28	3	M-47L-FF-2800	4
M-47-FF-3000	30	1.250	28	3	M-47L-FF-3000	4
M-47-FF-3400	34	1.50	32	4	M-47L-FF-3400	4.5
M-47-FF-3600	36	1.50	32	4	M-47L-FF-3600	4.5

Grade 2 Zinc plated nuts/bolts. Available in 304 and 316 stainless steel. Fiber gasket rated up to 1,800° F for continuous use, 2,300° F maximum temperature. One (1) gasket per set. Sizes 26" and up gaskets will come in two pieces.



### Standard Bolt Torque Specifications

Nominal Bolt Diameter (in.)	Dry Torque (Ft-Lbs)
0.375	20
0.50	47
0.625	96
0.75	155
0.875	206
1.00	310
1.125	480
1.250	375
1.50	1100

All dimensions are in inches. Larger sizes available.



# M-48 GASKETS

## Full Fiber Face Gaskets

### Fiber Full Face Engine Gaskets

Part Number	Engine	Size	ID	OD	THK
M-48-CAT-400-FF	CAT	4	4.1	5.5	0.0625
M-48-CAT-500-FF	CAT	5	5.1	6.5	0.0625
M-48-CAT-600-FF	CAT	6	6.1	7.8	0.0625
M-48-CAT-800-FF	CAT	8	8.1	11	0.0625
M-48-CAT-1000-FF	CAT	10	10.1	13.5	0.0625
M-48-CAT-1000-3516B	CAT	10	10.3	14	0.0625
M-48-CAT-1200-FF	CAT	12	12.1	16	0.0625
M-48-CAT-1400-FF	CAT	14	16.93	18.5	0.0625
M-48-CUM-600-FF	CUM	6	6	8	0.0625
M-48-MTU-600-FF	MTU	6	6.1	10.5	0.0625
M-48-MTU-800-FF	MTU	8	8.5	12.5	0.0625
M-48-MTU-1000-FF	MTU	10	10	13	0.0625



Fiber gasket rated up to 1,800° F for continuous use, 2,300° F maximum temperature.

### Fiber Full Face Gaskets

Part Number	Size	ID	OD	THK
M-48-FF-200	2	2	6	0.0625
M-48-FF-250	2.5	2.5	7	0.0625
M-48-FF-300	3	3	8.5	0.0625
M-48-FF-350	3.5	3.5	8.5	0.0625
M-48-FF-400	4	4.5	9	0.0625
M-48-FF-500	5	5.6	10	0.0625
M-48-FF-600	6	6.6	11	0.0625
M-48-FF-800	8	8.6	13.5	0.0625
M-48-FF-1000	10	10.8	16	0.0625
M-48-FF-1200	12	12.8	19	0.0625
M-48-FF-1400	14	14	21	0.0625
M-48-FF-1600	16	16	23.5	0.0625
M-48-FF-1800	18	18	25	0.0625
M-48-FF-2000	20	20	27.5	0.0625
M-48-FF-2200	22	22	29.5	0.0625
M-48-FF-2400	24	24	32	0.0625
M-48-FF-2600	26	26	34.5	0.0625
M-48-FF-2800	28	28	36.5	0.0625
M-48-FF-3000	30	30	38.8	0.0625
M-48-FF-3400	34	34	43.8	0.0625
M-48-FF-3600	36	36	46	0.0625



Fiber gasket rated up to 1,800° F for continuous use, 2,300° F maximum temperature. Sizes 26" and up gaskets will come in two pieces.

All dimensions are in inches. Larger sizes available.

# M-49 to M-51 TUBE FITTINGS

## Couplers and Reducer / Expanders

### Cuffed One End, Flex Hose Couplers / Stacks

Part Number	Tube Size	L	WT	Part Number	Tube Size	L	WT
M-49-200	2	4.5	0.46	M-49-500	5	6	1.58
M-49-250	2.5	4.5	0.57	M-49-600	6	6	1.89
M-49-300	3	5	0.77	M-49-800	8	8	2.33
M-49-350	3.5	5.5	1.00	M-49-1000	10	8	7
M-49-400	4	6	1.25	M-49-1200	12	10	10



### Cuffed Both Ends, Straight Tube Couplers

Part Number	Tube Size	L	WT	Part Number	Tube Size	L	WT
M-50-200	2	4.5	0.47	M-50-500	5	6.5	1.69
M-50-250	2.5	4.5	0.58	M-50-600	6	6.5	2.02
M-50-300	3	5	0.77	M-50-800	8	8.5	4
M-50-350	3.5	5.5	1.01	M-50-1000	10	8.5	5
M-50-400	4	6.5	1.36	M-50-1200	12	8.5	7

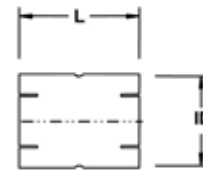

### Reducer / Expander, Style 1

Part Number	Tube Size	L	WT	Part Number	Tube Size	L	WT
M-51-2-225-1	2 X 2.25	6	0.65	M-51-35-450-1	3.5 X 4.5	7	1.45
M-51-2-250-1	2 X 2.5	6	0.70	M-51-35-500-1	3.5 X 5	8	1.68
M-51-25-300-1	2.5 X 3	6	0.86	M-51-4-450-1	4 X 4.5	6.5	1.41
M-51-3-350-1	3 X 3.5	6	1.05	M-51-4-500-1	4 X 5	8	1.88
M-51-3-400-1	3 X 4	6.5	1.17	M-51-5-550-1	5 X 5.5	6.5	1.79
M-51-35-400-1	3.5 X 4	6	1.17	M-51-5-600-1	5 X 6	8	2.29

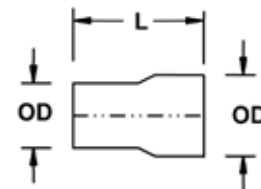

### Reducer / Expander, Style 2

Part Number	Tube Size	L	WT	Part Number	Tube Size	L	WT
M-51-2-225-2	2 X 2.25	6	0.67	M-51-35-450-2	3.5 X 4.5	7	1.49
M-51-2-250-2	2 X 2.5	6	0.71	M-51-35-500-2	3.5 X 5	8	1.64
M-51-25-300-2	2.5 X 3	6	0.85	M-51-4-450-2	4 X 4.5	6.5	1.50
M-51-3-350-2	3 X 3.5	6	1.00	M-51-4-500-2	4 X 5	8	1.88
M-51-3-400-2	3 X 4	6.5	1.28	M-51-5-550-2	5 X 5.5	6.5	1.90
M-51-35-400-2	3.5 X 4	6	1.17	M-51-5-600-2	5 X 6	8	2.46

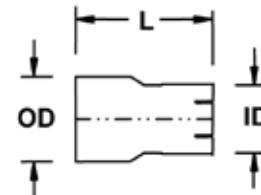

All dimensions are in inches. All weights are in pounds. Weights are approximate. Larger sizes available. Available in stainless steel.



# M-51 to M-52 TUBE FITTINGS

## Reducer / Expanders and Stack Breakers

### Reducer / Expander, Style 3

Part Number	Tube Size	L	WT	Part Number	Tube Size	L	WT
M-51-2-225-3	2 X 2.25	6	0.66	M-51-35-450-3	3.5 X 4.5	7	1.42
M-51-2-250-3	2 X 2.5	6	0.69	M-51-35-500-3	3.5 X 5	8	1.79
M-51-25-300-3	2.5 X 3	6	0.84	M-51-4-450-3	4 X 4.5	6.5	1.46
M-51-3-350-3	3 X 3.5	6	10.9	M-51-4-500-3	4 X 5	8	1.93
M-51-3-400-3	3 X 4	6.5	1.18	M-51-5-550-3	5 X 5.5	6.5	1.82
M-51-35-400-3	3.5 X 4	6	1.18	M-51-5-600-3	5 X 6	8	2.69

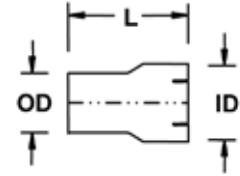

### Reducer / Expander, Style 4

Part Number	Tube Size	L	WT	Part Number	Tube Size	L	WT
M-51-2-225-4	2 X 2.25	6	0.66	M-51-35-450-4	3.5 X 4.5	7	1.46
M-51-2-250-4	2 X 2.5	6	0.72	M-51-35-500-4	3.5 X 5	8	1.71
M-51-25-300-4	2.5 X 3	6	0.88	M-51-4-450-4	4 X 4.5	6.5	1.48
M-51-3-350-4	3 X 3.5	6	1.03	M-51-4-500-4	4 X 5	8	1.89
M-51-3-400-4	3 X 4	7	1.18	M-51-5-550-4	5 X 5.5	6.5	1.79
M-51-35-400-4	3.5 X 4	6	1.19	M-51-5-600-4	5 X 6	8	2.12

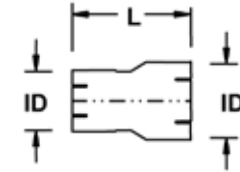

### Stack Breaker, includes 2 flanges and a clamp

Flange		Clamp		Set		
Part Number	WT	Part Number	WT	Part Number	WT	ID
M-52-200	0.23	M-52C-200	0.17	M-52E-200	0.64	2
M-52-250	0.29	M-52C-250	0.20	M-52E-250	0.77	2.5
M-52-300	0.34	M-52C-300	0.22	M-52E-300	0.90	3
M-52-350	0.40	M-52C-350	0.25	M-52E-350	1.0	3.5
M-52-400	0.45	M-52C-400	0.28	M-52E-400	1.2	4
M-52-500	0.56	M-52C-500	0.33	M-52E-500	1.5	5
M-52-600	0.66	M-52C-600	0.39	M-52E-600	1.7	6

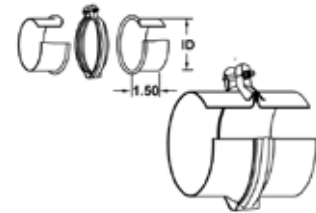

Stack breakers are leak tight. No gasket required.

### V-Clamp With Hinge, Open Ear Style

Part Number	Tube Size	Apex	WT	Part Number	Tube Size	APEX	WT
M-52C-200	2.0	0.207	0.17	M-52C-450	4.5	0.207	0.31
M-52C-250	2.5	0.207	0.20	M-52C-500	5	0.207	0.33
M-52C-300	3.0	0.207	0.22	M-52C-550	5.5	0.207	0.36
M-52C-350	3.5	0.207	0.25	M-52C-600	6	0.207	0.39
M-52C-400	4.0	0.207	0.28				

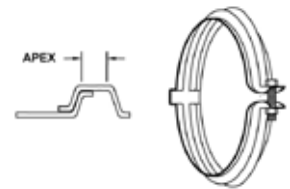

All dimensions are in inches. All weights are in pounds. Weights are approximate. Larger sizes available. Available in stainless steel.

# M-53 to M-55 ELBOWS

## 90° Elbows

### 90° Tube Elbow (Long Radius), Cuffed One End

Part Number	Size	B/C	R	WT	Part Number	Size	B/C	R	WT
M-53-200	2	6	4	1	M-53-350	3.5	10	7	3.3
M-53-225	2.25	6.5	4.5	1.5	M-53-400	4	11.5	8	4
M-53-250	2.5	7	5	1.5	M-53-450	4.5	13	9	5.5
M-53-275	2.75	8	5.5	1.7	M-53-500	5	14	10	6.5
M-53-300	3	8.5	6	2.3	M-53-600	6	17	12	9.5

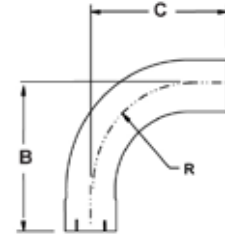

### 90° Tube Elbow (Long Radius), OD Tube Both Ends

Part Number	Size	B/C	R	WT	Part Number	Size	B/C	R	WT
M-54-200	2	6	4	1	M-54-350	3.5	10	7	3.3
M-54-225	2.25	6.5	4.5	1.5	M-54-400	4	11.5	8	4
M-54-250	2.5	7	5	1.5	M-54-450	4.5	13	9	5.5
M-54-275	2.75	8	5.5	1.7	M-54-500	5	14	10	6.5
M-54-300	3	8.5	6	2.3	M-54-600	6	17	12	9.5

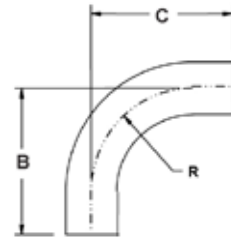

### 90° Tube Elbow (Short Radius), Tangent Cut

Part Number	Size	B/C	R	WT	Part Number	Size	B/C	R	WT
M-55-200	2	2	2	0.3	M-55-450	4.5	4.5	4.5	1.8
M-55-225	2.25	2.25	2.25	0.4	M-55-500	5	5	5	2
M-55-250	2.5	2.5	2.5	0.5	M-55-600	6	6	6	6
M-55-275	2.75	2.75	2.75	0.6	M-55-800	8	8	8	10
M-55-300	3	3	3	0.7	M-55-1000	10	10	10	12
M-55-350	3.5	3.5	3.5	1	M-55-1200	12	12	12	16
M-55-400	4	4	4	1.3					

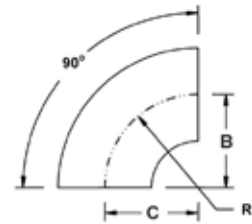

### 90° Mitered Elbow (Short Radius), Tangent Cut

Part Number	A	B	C	WT	Part Number	A	B	C	WT
M-55-M-800	8	8	8	10	M-55-M-2000	20	20	20	79
M-55-M-1000	10	10	10	16	M-55-M-2200	22	22	22	95
M-55-M-1200	12	12	12	22	M-55-M-2400	24	24	24	113
M-55-M-1400	14	14	14	30	M-55-M-2600	26	26	26	133
M-55-M-1600	16	16	16	50	M-55-M-2800	28	28	28	154
M-55-M-1800	18	18	18	64	M-55-M-3000	30	30	30	327

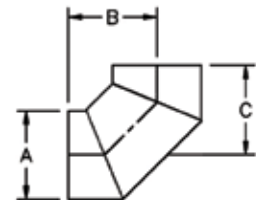

All dimensions are in inches. All weights are in pounds. Weights are approximate. Larger sizes available. Available in stainless steel.





# M-56 to M-59 ELBOWS

## 90° and 45° Elbows

### 90° Tube Elbow (Short Radius), Cuffed One End

Part Number	Size	B/C	R	WT	Part Number	Size	B/C	R	WT
M-56-200	2	4	2	0.6	M-56-450	4.5	8	4.5	3.4
M-56-225	2.25	4	2.25	0.8	M-56-500	5	9	5	4.3
M-56-250	2.5	4.5	2.5	1	M-56-600	6	11	6	6.3
M-56-275	2.75	5	2.75	1.4	M-56-800	8	15	8	11.5
M-56-300	3	5.5	3	1.6	M-56-1000	10	19	10	14.5
M-56-350	3.5	6.5	3.5	2.2	M-56-1200	12	23	12	18
M-56-400	4	7.5	4	2.8					

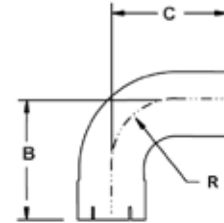

### 90° Tube Elbow (Short Radius), OD Tube Both Ends

Part Number	Size	B/C	R	WT	Part Number	Size	B/C	R	WT
M-57-200	2	4	2	0.7	M-57-450	4.5	8	4.5	3.3
M-57-225	2.25	4	2.25	0.8	M-57-500	5	9	5	4.3
M-57-250	2.5	4.5	2.5	1	M-57-600	6	11	6	6.5
M-57-275	2.75	5	2.75	1.3	M-57-800	8	15	8	12
M-57-300	3	5.5	3	1.5	M-57-1000	10	19	10	15
M-57-350	3.5	6.5	3.5	2.2	M-57-1200	12	23	12	19
M-57-400	4	7.5	4	2.7					

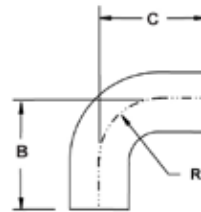

### 45° Tube Elbow (Long Radius), Cuffed One End

Part Number	Size	B/C	R	WT	Part Number	Size	B/C	R	WT
M-58-200	2	4	4	0.8	M-58-350	3.5	6.5	7	2.5
M-58-225	2.25	4.5	4.5	1	M-58-400	4	7	8	2.8
M-58-250	2.5	5	5	1.4	M-58-450	4.5	7.5	9	3.6
M-58-275	2.75	5.5	5.5	1.6	M-58-500	5	8	10	4.3
M-58-300	3	5.5	6	1.7	M-58-600	6	10	12	6.7

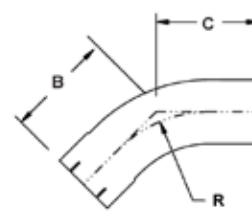

### 45° Tube Elbow (Long Radius), OD Tube Both Ends

Part Number	Size	B/C	R	WT	Part Number	Size	B/C	R	WT
M-59-200	2	4	4	0.8	M-59-350	3.5	6.5	7	2.3
M-59-225	2.25	4.5	4.5	1.1	M-59-400	4	7	8	2.8
M-59-250	2.5	5	5	1.2	M-59-450	4.5	7.5	9	3.6
M-59-275	2.75	5.5	5.5	1.5	M-59-500	5	8	10	4.2
M-59-300	3	5.5	6	1.8	M-59-600	6	10	12	6.6

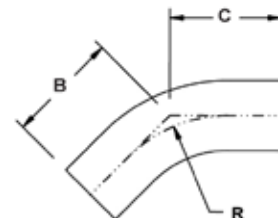

All dimensions are in inches. All weights are in pounds. Weights are approximate. Larger sizes available. Available in stainless steel.

# M-60 to M-62 ELBOWS

## 45° Elbows

### 45° Tube Elbow (Short Radius), Cuffed One End

Part Number	Size	B/C	R	WT	Part Number	Size	B/C	R	WT
M-60-200	2	3	2	0.6	M-60-350	3.5	4.5	3.5	1.6
M-60-225	2.25	3	2.25	0.7	M-60-400	4	5	4	2
M-60-250	2.5	3.5	2.5	0.9	M-60-450	4.5	5.5	4.5	2.7
M-60-275	2.75	3.75	2.75	1.1	M-60-500	5	6	5	3.2
M-60-300	3	4	3	1.2	M-60-600	6	7	6	4.7

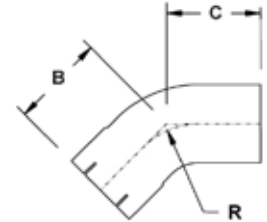

### 45° Tube Elbow (Short Radius), OD Tube Both Ends

Part Number	Size	B/C	R	WT	Part Number	Size	B/C	R	WT
M-61-200	2	3	2	0.6	M-61-350	3.5	4.5	3.5	1.7
M-61-225	2.25	3	2.25	0.7	M-61-400	4	5	4	2.1
M-61-250	2.5	3.5	2.5	0.9	M-61-450	4.5	5.5	4.5	2.7
M-61-275	2.75	3.75	2.75	1.1	M-61-500	5	6	5	3.2
M-61-300	3	4	3	1.2	M-61-600	6	7	6	4.6

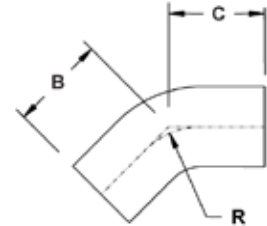

### 45° Tube Elbow (Short Radius), Tangent Cut

Part Number	Size	R	WT	Part Number	Size	R	WT
M-62-200	2	2	0.2	M-62-450	4.5	4.5	0.8
M-62-225	2.25	2.25	0.2	M-62-500	5	5	1
M-62-250	2.5	2.5	0.3	M-62-600	6	6	1.5
M-62-275	2.75	2.75	0.3	M-62-800	8	8	2.6
M-62-300	3	3	0.4	M-62-1000	10	10	4.1
M-62-350	3.5	3.5	0.5	M-62-1200	12	12	6
M-62-400	4	4	0.7				

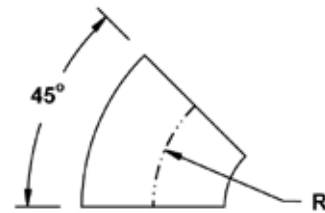

All dimensions are in inches. All weights are in pounds. Weights are approximate. Larger sizes available. Available in stainless steel.



# M-63 to M-65 FLEX and TUBING

## Interlocking Flex, Tubing, and Corrugated Flex

### Interlocking Flex Hose, 304 Stainless Steel

Part Number	ID	OD	WT/FT	Part Number	ID	OD	WT/FT
M-63-200-S	2	2.16	1.50	M-63-500-S	5	5.16	3.1
M-63-250-S	2.5	2.66	1.60	M-63-600-S	6	6.16	3.7
M-63-300-S	3	3.16	1.80	M-63-800-S	8	8.16	4.6
M-63-350-S	3.5	3.66	1.90	M-63-1000-S	10	10.16	6.2
M-63-400-S	4	4.16	2.50				

Available in galvanized.

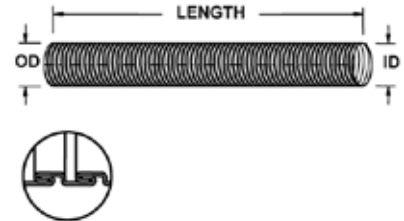

### Tubing, Carbon Steel

Part Number	OD	Wall Thk	WT/FT	Part Number	OD	Wall Thk	WT/FT
M-64-150	1.5	0.065	1.00	M-64-800	8	0.083	9
M-64-200	2	0.065	1.30	M-64-1000	10	0.107	14.3
M-64-225	2.25	0.065	1.50	M-64-1200	12	0.107	15
M-64-250	2.5	0.065	1.70	M-64-1400	14	0.134	16.2
M-64-275	2.75	0.065	1.90	M-64-1600	16	0.107	18.5
M-64-300	3	0.065	2.00	M-64-1800	18	0.134	Call
M-64-350	3.5	0.065	2.40	M-64-2000	20	0.134	Call
M-64-400	4	0.065	2.70	M-64-2200	22	0.134	Call
M-64-450	4.5	0.065	3.10	M-64-2400	24	0.134	Call
M-64-500	5	0.065	3.40	M-64-2600	26	0.134	Call
M-64-550	5.5	0.065	3.40	M-64-2800	28	0.134	Call
M-64-600	6	0.083	5.00	M-64-3000	30	0.134	Call



### Corrugated Flex Hose, 321 Stainless Steel

Part Number	ID	OD	Part Number	ID	OD
M-65-150	1.5	2.19	M-65-500	5	5.87
M-65-200	2.5	2.75	M-65-600	6	6.94
M-65-250	2.5	3.17	M-65-800	8	9
M-65-300	3	3.75	M-65-1000	10	11
M-65-350	3.5	4.38	M-65-1200	12	13
M-65-400	4	4.82			

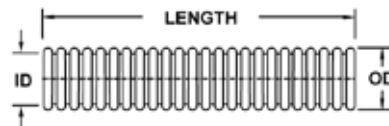

All dimensions are in inches. All weights are in pounds. Weights are approximate. Larger sizes available. Available in stainless steel.

# M-67 CONES

## Concentric Expansion Connectors

### Cones, No Flanges

Part Number	A	B	C
M-67-00-6080	6	8	9.5
M-67-00-6010	6	10	11.5
M-67-00-8010	8	10	11.5
M-67-00-8012	8	12	11.5
M-67-00-1012	10	12	11.5
M-67-00-1014	10	14	11.5
M-67-00-1214	12	14	11.5
M-67-00-1216	12	16	11.5
M-67-00-1416	14	16	13.5
M-67-00-1418	14	18	13.5
M-67-00-1618	16	18	15.5
M-67-00-1620	16	20	15.5
M-67-00-1820	18	20	15.5
M-67-00-1822	18	22	15.5
M-67-00-2022	20	22	15.5
M-67-00-2024	20	24	15.5
M-67-00-2224	22	24	15.5
M-67-00-2226	22	26	15.5

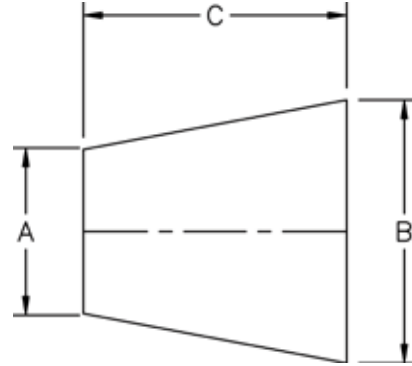

### Cones, Flanged Both Ends

Part Number	A	B	C
M-67-11-6080	6	8	10
M-67-11-6010	6	10	12
M-67-11-8010	8	10	12
M-67-11-8012	8	12	12
M-67-11-1012	10	12	12
M-67-11-1014	10	14	12
M-67-11-1214	12	14	12
M-67-11-1216	12	16	12
M-67-11-1416	14	16	14
M-67-11-1418	14	18	14
M-67-11-1618	16	18	16
M-67-11-1620	16	20	16
M-67-11-1820	18	20	16
M-67-11-1822	18	22	16
M-67-11-2022	20	22	16
M-67-11-2024	20	24	16
M-67-11-2224	22	24	16
M-67-11-2226	22	26	16

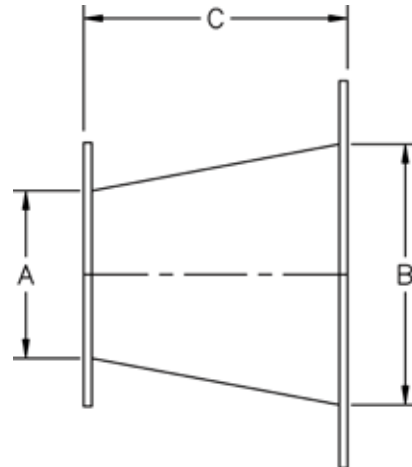

All ANSI flanges may be replaced with a standard Caterpillar, Cummins, or MTU engine flanges.

All dimensions are in inches. Larger sizes available. Available in stainless steel.



# M-80 to M-82 RAIN GUARDS to DRAIN COCKS

## Rain Guards and Drain Cocks

### Rain Guards, ANSI Flange Style

Part Number	A	B	C	THK
M-80-400	4	15	4	0.083
M-80-500	5	15	4	0.083
M-80-600	6	15	4	0.083
M-80-800	8	18	4	0.083
M-80-1000	10	20	4	0.083
M-80-1200	12	24	4	0.083
M-80-1400	14	24	4	0.083

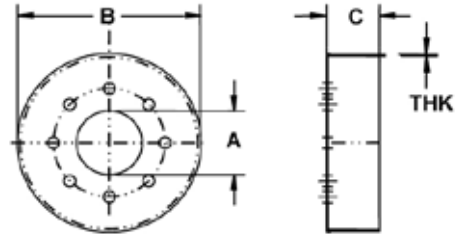

### Rain Guards, ID Cuff Style

Part Number	A	B	C	THK
M-81-400	4	15	4	0.083
M-81-450	4.5	15	4	0.083
M-81-500	5	15	4	0.083
M-81-556	5.56	15	4	0.083
M-81-600	6	15	4	0.083
M-81-663	6.63	15	4	0.083
M-81-800	8	18	4	0.083
M-81-863	8.63	18	4	0.083
M-81-1000	10	20	4	0.083
M-81-1075	10.75	20	4	0.083
M-81-1200	12	24	4	0.083
M-81-1275	12.75	24	4	0.083
M-81-1400	14	24	4	0.083

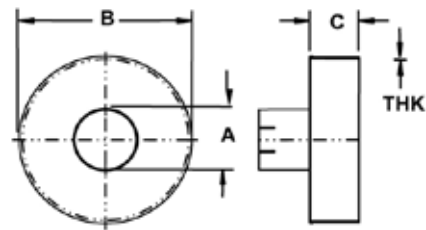

### Drain Cocks

Part Number	Port	Pipe Size
M-82-0500	Full	0.50
M-82-0750	Standard	0.75
M-82-0100	Standard	1.00
M-82-0150	Standard	1.50

Bronze ball valve (union x NPT female).  
 Ball is chrome plated brass.  
 Latch lock handle allows padlock.  
 Includes 4" long NPT male nipple adapter.

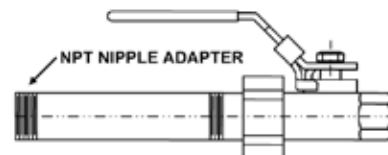

# M-103 to M-106 WRAP SPECIFICATIONS

## Thermal Insulation Wrap Technical Specifications

Custom, removable, reusable, flexible, thermal insulation wrap provides a tough, durable exterior that can be custom fitted for nearly any product or accessory. Maxim Thermal wrap is composed of 1" thick, 11 lb. insulation composed of 100% Type "E" fibers, fabricated in a mat form free of asbestos. The wrap is easy to install, and significantly reduces surface temperature.

### Custom Designed Flexible, Removable Insulation Blankets

Properties	Specification Range
Temperature Range	- 67° F - 1200° F
Thickness	Standard 1", available from .5" to 4"
Insulation	High Density - 11 lb./ cu. ft. - 100% select grade Type "E" glass fibers needled together into mat form. It is Non-respirable, incombustible, asbestos free and contains no resinous or inorganic binders.
Inner Liner	304 stainless steel mesh. Stainless steel foil liners are available.
Outer Liner	Grey Silicone impregnated fiberglass cloth for process temperatures up to 1000° F and 304 stainless steel mesh.
Construction	All seams are held together with 304 stainless steel "hog ring" staples.
Attachments	Tie down anchors, lacing hooks and washers are 304 stainless steel
Tags, optional	Stainless Steel
Installation	Thermal blankets are hand formed around work piece and laced with stainless steel 16 gauge lacing wire

### Specification Compliance

MIL-1-24244

NRC-136

NFPA 255 & 110

UL 492 (Self Extinguishing)

US Coast Guard Certificate 164.009/94/0

Various inner/outer liners and insulation materials are available depending on application and specification. Our technicians can help make recommendation to meet your requirements or a desired outer surface temperature. Please specify process operating temperature when inquiring.



# M-103 to M-104 ACCESSORY WRAP

## Tube and Bellows Thermal Wrap

### Tubing, Wrap

Tube/Pipe			Tube/Pipe		
Part Number	Size	Application	Part Number	Size	Application
M-103-300-W	3	Tube	M-103-1200-W	12	Tube
M-103-350-W	3.5	Tube & 3" Pipe	M-103-1275-W	12.75	Pipe
M-103-400-W	4	Tube & 3.5" Pipe	M-103-1400-W	14	Pipe
M-103-450-W	4.5	Pipe	M-103-1600-W	16	Pipe
M-103-500-W	5	Tube	M-103-1800-W	18	Pipe
M-103-556-W	5.56	Pipe	M-103-2000-W	20	Pipe
M-103-600-W	6	Tube	M-103-2200-W	22	Pipe
M-103-663-W	6.63	Pipe	M-103-2400-W	24	Pipe
M-103-800-W	8	Tube	M-103-2600-W	26	Pipe
M-103-863-W	8.63	Pipe	M-103-2800-W	28	Pipe
M-103-1000-W	10	Tube	M-103-3000-W	30	Pipe
M-103-1075-W	10.75	Pipe	M-103-3600-W	36	Pipe

### Flex, Wrap

Part Number	Size ID	Part Number	Size ID
M-104-F-300-W	3	M-104-F-600-W	6
M-104-F-350-W	3.5	M-104-F-800-W	8
M-104-F-400-W	4	M-104-F-1000-W	10
M-104-F-500-W	5	M-104-F-1200-W	12

### Bellows, Wrap

Part Number	Size ID	Part Number	Size ID
M-104-B-300-W	3	M-104-B-1600-W	16
M-104-B-350-W	3.5	M-104-B-1800-W	18
M-104-B-400-W	4	M-104-B-2000-W	20
M-104-B-500-W	5	M-104-B-2200-W	22
M-104-B-600-W	6	M-104-B-2400-W	24
M-104-B-800-W	8	M-104-B-2600-W	26
M-104-B-1000-W	10	M-104-B-2800-W	28
M-104-B-1200-W	12	M-104-B-3000-W	30
M-104-B-1400-W	14	M-104-B-3600-W	36

All dimensions are in inches. Larger sizes available.

# M-105 ACCESSORY WRAP

## Elbow Thermal Wrap

### 45° Tube Elbow (Long Radius), Wrap

Part Number	Size	Application	Part Number	Size	Application
M-105-45-300-LR	3	Tube	M-105-45-500-LR	5	Tube
M-105-45-350-LR	3.5	Tube & Pipe	M-105-45-556-LR	5.56	Pipe
M-105-45-400-LR	4	Tube	M-105-45-600-LR	6	Tube
M-105-45-450-LR	4.5	Pipe			

### 45° Tube Elbow (Short Radius-Tangent Cut), Wrap

Part Number	Size	Application	Part Number	Size	Application
M-105-45-300-SR	3	Tube	M-105-45-663-SR	6.63	Pipe
M-105-45-350-SR	3.5	Tube & Pipe	M-105-45-800-SR	8	Tube
M-105-45-400-SR	4	Tube	M-105-45-863-SR	8.63	Pipe
M-105-45-450-SR	4.5	Pipe	M-105-45-1000-SR	10	Tube
M-105-45-500-SR	5	Tube	M-105-45-1075-SR	10.75	Pipe
M-105-45-556-SR	5.56	Pipe	M-105-45-1200-SR	12	Tube
M-105-45-600-SR	6	Tube	M-105-45-1275-SR	12.75	Pipe

### 90° Tube Elbow (Long Radius), Wrap

Part Number	Size	Application	Part Number	Size	Application
M-105-300-LR	3	Tube	M-105-500-LR	5	Tube
M-105-350-LR	3.5	Tube & Pipe	M-105-556-LR	5.56	Pipe
M-105-400-LR	4	Tube	M-105-600-LR	6	Tube
M-105-450-LR	4.5	Pipe			

### 90° Tube Elbow (Short Radius-Tangent Cut), Wrap

Part Number	Size	Application	Part Number	Size	Application
M-105-300-SR	3	Tube	M-105-663-SR	6.63	Pipe
M-105-350-SR	3.5	Tube & Pipe	M-105-800-SR	8	Tube
M-105-400-SR	4	Tube	M-105-863-SR	8.63	Pipe
M-105-450-SR	4.5	Pipe	M-105-1000-SR	10	Tube
M-105-500-SR	5	Tube	M-105-1075-SR	10.75	Pipe
M-105-556-SR	5.56	Pipe	M-105-1200-SR	12	Tube
M-105-600-SR	6	Tube	M-105-1275-SR	12.75	Pipe

All dimensions are in inches. Larger sizes available. All elbow wraps are for tangent cut elbows. Elbow wraps with extended legs, available.





# M-105 to M-106 ACCESSORY WRAP

## Mitered Elbow and Flange Thermal Wrap

### 90° Mitered Elbow (Short Radius), Wrap

Part Number	Size	Application	Part Number	Size	Application
M-105-M-800-SR	8	Tube	M-105-M-2000-SR	20	Tube
M-105-M-1000-SR	10	Tube	M-105-M-2200-SR	22	Tube
M-105-M-1200-SR	12	Tube	M-105-M-2400-SR	24	Tube
M-105-M-1400-SR	14	Tube	M-105-M-2600-SR	26	Tube
M-105-M-1600-SR	16	Tube	M-105-M-2800-SR	28	Tube
M-105-M-1800-SR	18	Tube	M-105-M-3000-SR	30	Tube

### ANSI Flange, Wrap

Part Number	Nominal Size	Part Number	Nominal Size
M-106-300-W	3	M-106-1800-W	18
M-106-350-W	3.5	M-106-2000-W	20
M-106-400-W	4	M-106-2200-W	22
M-106-500-W	5	M-106-2400-W	24
M-106-600-W	6	M-106-2600-W	26
M-106-800-W	8	M-106-2800-W	28
M-106-1000-W	10	M-106-3000-W	30
M-106-1200-W	12	M-106-3200-W	32
M-106-1400-W	14	M-106-3400-W	34
M-106-1600-W	16	M-106-3600-W	36

Wrap will cover two flanges bolted together

## Accessory Specifications Standard Terms and Conditions

All quotations/orders are made subject to the following Standard Terms and Conditions, unless otherwise specified within the body of the formal quotation/ order, in which case that section or paragraph only would be superseded. (In the case of a catalytic silencer, all Standard Terms and Conditions apply except that the LIMITED WARRANTY provision is superseded by the provisions contained in the document entitled "LIMITED WARRANTY AS APPLIED TO CATALYTIC SILENCER.") No deviations from or changes to these Terms and Conditions will be honored or recognized without prior negotiation and written agreement between the Seller and Purchaser.

**PRICING:** All quotations are made for immediate acceptance and are subject to change without notice, unless otherwise noted. Prices quoted herein are based on the current costs of material and labor and are subject to escalation. Said escalation shall be determined by the cost of material to Seller on the date of shipment of said material from Supplier, and the costs of labor during the fabrication cycle.

**DELIVERY:** All delivery promises quoted are subject to prior commitment of shop capacity before the receipt of a firm purchase order by Seller. If shipment is delayed by Purchaser, payment shall become due when Purchaser is notified that equipment is ready for shipment and equipment will henceforth be held at Purchaser's risk and expense.

**PAYMENT:** Purchaser agrees to pay invoiced amount to Seller on or before thirty (30) days from date of invoice unless otherwise specified and/or agreed upon in writing. All past due accounts are subject to interest at the rate of one percent (1 %) per month on the unpaid balance.

**CREDIT:** The Seller is not bound by the provisions hereof with regard to any order until said order has been approved in writing by an authorized representative of Seller's Credit Department

**CANCELLATION:** Cancellation shall be affected only by a written agreement and Purchaser will assume full liability for payment of any and all cancellation charges.

**RETURNED GOODS:** No material will be accepted for credit without Seller's written consent and then only under the terms of such consent.

**LIMITED WARRANTY:** Seller warrants only goods of its own manufacture and then only to the extent that they are free from defects in material and workmanship under normal use and service for the purpose for which they were manufactured and when correctly installed and maintained within one (1) year from the date of shipment. This warranty is limited to repair or replacement of the goods F.O.B. point of manufacture at the Seller's option. Seller does not warrant secondhand material. THESE WARRANTIES ARE EXCLUSIVE AND ARE IN LIEU OF ALL OTHER WARRANTIES, EXPRESS, IMPLIED OR STATUTORY, INCLUDING THE WARRANTY OF MERCHANTABILITY AND FITNESS FOR A PARTICULAR PURPOSE. Purchaser waives any warranties of any kind whatsoever including but not limited to a waiver of any warranties of fitness, any warranties as to the suitability of the product for its intended use, and any warranties as to the return of the purchase price. It is further understood and agreed that this is Purchaser's only remedy for all claims arising or relating to the goods purchased hereunder for breach of contract and tort including negligence and strict liability and any other legal theory. Seller shall not be responsible for deterioration of any part or parts of the equipment due to corrosion, erosion or any other causes, regardless of when such deterioration occurs, after leaving the manufacturer's premises. No allowance will be granted for repairs or alterations made by Purchaser or at Purchaser's direction without Seller's written consent. Seller shall not be liable for consequential, incidental or any damages other than repair or replacement of defective goods at Seller's option. It is understood that Seller makes no warranty except as expressly stipulated herein and Seller's liability is limited as above set forth. **NOT WARRANTED:** Maxim offers no paint guarantees other than preparation and application in accordance with manufacturer's instructions. The primary purpose of "factory black" standard coating is not aesthetic but for corrosion resistance and shipping protection. No heat curing is available. If required, curing must be done in service at the direction of others.

No representative has the authority to make any representation, promise or agreement except as stated herein.

**TAXES:** The Purchaser shall pay to the Seller in addition to the purchase price, the amount of any excise, sales, privilege, or use tax, local, state or federal, which is payable by the Seller because of the execution of this contract or sale or delivery of the apparatus covered hereby.

## Accessory Specifications Standard Terms and Conditions

**PATENTS:** Notwithstanding any language to the contrary in specifications, purchase orders or elsewhere, Seller shall not be responsible for any patent infringement, or claim of patent infringement with respect to products furnished in accordance with the Purchaser's specifications or design requirements, and Purchaser shall indemnify and save Seller harmless from all claims, demands or suits growing out of or based on any patent infringement or claim thereof, arising there from.

**FORCE MAJEURE:** Seller shall not be liable for any delay in delivery or for non-delivery, in whole or in part caused by the occurrence of any contingency beyond the control either of Seller or suppliers to the Seller, including but not limited to war (whether an actual declaration thereof is made or not), sabotage, insurrection, rebellion, riot or other act of civil disobedience, act of a public enemy, failure or delay in transportation, act of any government or any agency or subdivision thereof, judicial action, labor dispute, fire, accident explosion, epidemic, quarantine, restrictions, storm, flood, earthquake, or other act of God, shortage of labor, fuel, raw material or machinery or technical failure, where Seller has exercised ordinary care in the prevention thereof. If any contingency occurs, Seller may allocate production and deliveries among Seller's customers.

**CONFIDENTIAL INFORMATION:** All drawings, diagrams, specifications and other materials furnished by Seller and identified as confidential relating to the use and service of articles furnished hereunder and the information therein are proprietary to Seller. Such materials have been developed at great expense and they contain trade secrets of the Seller. Buyer may not reproduce or distribute such materials except to Buyer's employees who may use the articles as part of their duties. All such materials relating to the article supplied directly by Seller (except information as may be established to be in the public domain or disclosed pursuant to judicial government action) shall be received in confidence and Buyer shall exercise reasonable care to hold such information in confidence.

**TECHNICAL ASSISTANCE:** Seller's warranty shall not be enlarged and no obligation or liability shall arise out of Seller's rendering of technical advice, facilities or services in connection with Buyer's order for the goods furnished.

**DISPUTES:** This agreement is deemed to be entered into in Texas and to be a Texas contract and shall be governed and construed in accordance with the laws of the State of Texas. Except as otherwise specifically provided for herein Seller and Buyer specifically agree that any legal action brought relating to goods purchased or relating to this contract will be brought and tried in Texas. All objections to venue are hereby waived by the Buyer, and the Buyer consents to service of process by certified mail addressed to the same address as that address designated for delivery of the goods purchased hereunder. In the event of any suit for the collection of funds instituted by the Seller, the prevailing party with respect to such collection matter shall be entitled to reasonable attorney's fees as determined by the court to prevail in Texas.

**Industrial Silencer, Heat Recovery and Catalytic Specialists**

**Maxim Silencers  
Accessory  
Catalog**

